

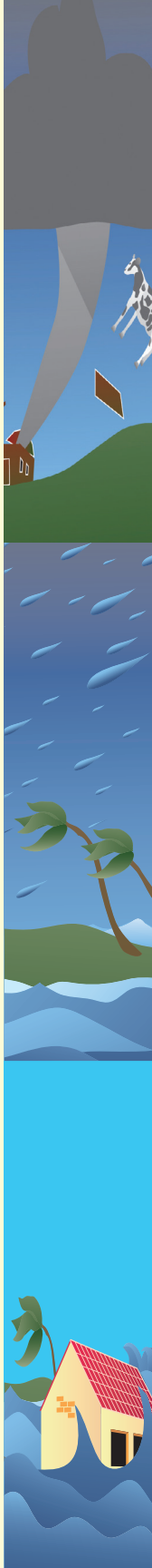

F L O R I D A

HOMEOWNERS HANDBOOK TO PREPARE FOR NATURAL HAZARDS



UF UNIVERSITY of
FLORIDA
IFAS Extension





This book was developed as a project of the Gulf of Mexico Alliance (GOMA), a partnership of federal, state, and local organizations that share a vision for healthy and resilient communities. One key priority of GOMA is to increase the resiliency of coastal communities from natural hazards. One major component of healthy communities is enhancing individual resilience and recognizing that adjustments to day-to-day living are necessary. This book is designed to promote individual resilience; thereby creating a fortified community.

This is the QR code for the Gulf of Mexico Alliance - Florida:
<http://www.gulfofmexicoalliance.org/state-by-state/florida.php>



Partners of GOMA that collaborated on this book include the Apalachicola National Estuarine Research Reserve (ANERR), Florida Department of Emergency Management (FDEM), Florida Department of Health (FDOH), Florida Forest Service (FFS), Florida Sea Grant College Program (Florida Sea Grant), and the University of Florida's Institute of Food and Agricultural Sciences Extension (UF/IFAS Extension). Authors include Harris Berns-Cadle, Randall Cantrell, Libby Carnahan, Ronnie Fetzko, Dennis Hwang, Rosalyn F. Kilcollins, Darren Okimoto, Janna Rosenthal, Brooke Saari, Todd Schroeder, and Michael Spranger. This publication was supported by the Environmental Protection Agency's Gulf of Mexico Program, award number MX95452810, as well as GOMA Coastal Community Resilience Team under NOAA number NA08NOS473398. The views expressed herein are those of the author(s) and do not necessarily reflect the views of ANERR, FDEM, FDOH, FFS, Florida Sea Grant, GOMA, UF/IFAS Extension, or any of its subagencies.

This document as well as other Coastal Storms Program documents is available as a part of a searchable database available at the Coastal Storms Program website: <http://www.csc.noaa.gov/csp>.

Homeowner's Handbook for Natural Hazards in Florida

The Gulf of Mexico Alliance would like to thank the University of Hawai'i Sea Grant College Program for allowing us to model this handbook after the original Homeowner's Handbook authored by Dennis Hwang and Darren Okimoto. A special thanks to Darren and Dennis for providing text and graphics in the preparation of the Florida handbook.

ISBN: 978-0-9850952-2-2

Contents

| | |
|-----------------------------------------------------------------|-----------|
| Part 1 Introduction | 1 |
| 1.1 Common Myths and Reasons to Prepare | 2 |
| 1.2 Ten Things You Can Do to Prepare | 5 |
| Part 2 Natural Hazards: An Overview for Homeowners | 9 |
| 2.1 Tornado Hazards | 9 |
| 2.2 Intense Tropical Storm Hazards | 11 |
| 2.2.1 Tropical Storms..... | 11 |
| 2.2.2 Hurricanes | 12 |
| 2.3 Flood Hazards | 16 |
| 2.4 Wildlife Hazards..... | 17 |
| Part 3 Protecting Yourself and Your Family..... | 19 |
| 3.1 Emergency Supplies..... | 19 |
| 3.2 Evacuation Kit..... | 22 |
| 3.3 Evacuation Planning | 23 |
| 3.3.1 Key Definitions..... | 24 |
| 3.3.2 Emergency Alert System..... | 25 |
| 3.4 Sheltering in Place..... | 27 |
| 3.5 Preparations Before a Hurricane | 32 |
| 3.6 Evacuation Procedures for a Hurricane..... | 34 |
| 3.7 Preparedness and Safety Procedures for a Tornado | 35 |
| 3.8 Evacuation Procedures for a Flood..... | 37 |
| 3.9 After the Disaster | 38 |
| 3.10 Emergency Information and Contacts..... | 40 |

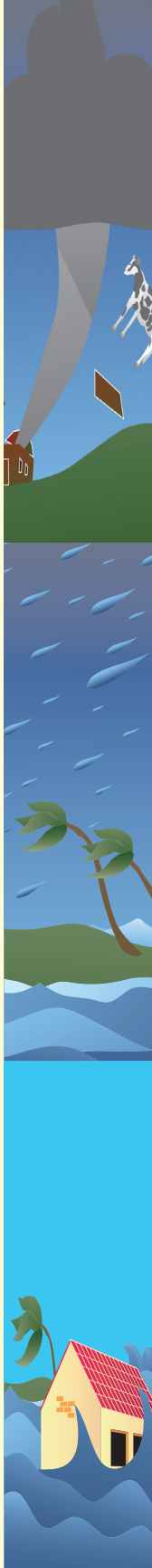

Part 4 Protecting Your Property43

| | |
|-----------------------------------------------------------------|----|
| 4.1 Creating the Wind- and Rain-Resistant Envelope..... | 43 |
| 4.1.1 Creating a Strong Hurricane Resistant Roof..... | 47 |
| 4.1.2 Minimize Water Entry Through Your Ventilation System..... | 49 |
| 4.2 Protection for Windows, Doors and Garage Doors..... | 49 |
| 4.2.1 Roll-down Shutters | 51 |
| 4.2.2 Accordion Shutters..... | 52 |
| 4.2.3 Decorative/ Protective Shutters | 52 |
| 4.2.4 Storm Panels..... | 53 |
| 4.2.5 In-Place Systems..... | 54 |
| 4.2.6 Fabric Windscreen..... | 55 |
| 4.2.7 Impact-Resistant Glass Systems | 55 |
| 4.2.8 Plastic Honeycomb Panels..... | 56 |
| 4.2.9 Window Film..... | 56 |
| 4.2.10 Impact-Resistant Garage and Entry Doors..... | 57 |
| 4.2.11 Plywood Shutters | 59 |
| 4.3 Installing Plywood Shutters | 60 |
| 4.3.1 Obtaining Assistance..... | 60 |
| 4.3.2 Material to Use..... | 60 |
| 4.3.3 Measuring Your Windows and Cutting the Plywood..... | 61 |
| 4.3.4 Fasteners and Attaching the Panels..... | 61 |
| 4.3.5 Deployment | 62 |
| 4.3.6 Other Methods of Installation | 63 |
| 4.3.7 Storing Plywood Panels | 64 |
| 4.3.8 Timing Deployment with a Hurricane Watch or Warning | 64 |
| 4.4 Trees | 49 |
| 4.5 Safe Rooms..... | 66 |
| 4.5.1 The Safe Room | 66 |
| 4.6 Improving Structural Resistance to Wind Damage..... | 67 |
| 4.6.1 Strengthening Gable Ends | 67 |
| 4.6.2 Continuous Load Path Connections | 67 |



| | |
|--------------------------------------------------------|----|
| 4.7 Retrofitting an Existing Home..... | 70 |
| 4.7.1 Roof-to-wall Connections | 71 |
| 4.7.2 Foundation Uplift Strengthening Restraint..... | 72 |
| 4.8 Other Measures to Protect Your Property | 72 |
| 4.9 Flood Retrofit..... | 72 |
| 4.9.1 Flood Prevention | 72 |
| 4.10 Protecting Your Home and Property From Fire | 74 |
| 4.11 Hazard Mitigation Assistance Program | 79 |
| 4.12 Licensed Contractors | 80 |
| 4.13 Electrical and Power Issues..... | 81 |
| 4.13.1 Alternate Power Sources | 83 |
| 4.13.2 Generators | 83 |
| 4.13.3 Power Stations..... | 85 |
| 4.13.4 Inverters | 85 |
| 4.13.5 Battery Chargers | 85 |

Part 5 Protecting Your Property with Insurance87

| | |
|--------------------------------------------------------------------------|----|
| 5.1 Hurricane Insurance | 87 |
| 5.1.1 Insurance Discounts for Installation of Hurricane Protection | 90 |
| 5.2 Flood Insurance | 91 |
| 5.3 General Insurance Information..... | 92 |
| 5.3.1 Keeping a Household Inventory and Protecting Valuable Records..... | 92 |
| 5.3.2 Making an Insurance Claim..... | 93 |

Part 6 Climate Change and Potential Impacts on Natural Hazards .95

| | |
|------------------------------------------------------|----|
| 6.1 Climate Change | 95 |
| 6.2 Regional Climate Trends | 96 |
| 6.3 Potential Climate Change Impacts in Florida..... | 96 |
| 6.3.1 Coastal Storms..... | 97 |
| 6.3.2 Floods and Droughts..... | 97 |
| 6.3.3 Sea-Level Rise..... | 98 |

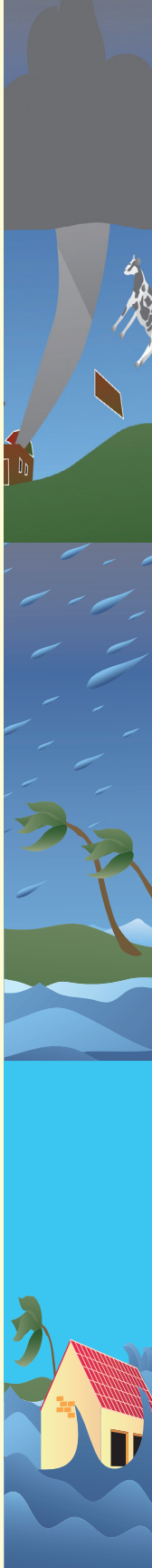



| | |
|------------------------------------------------------------------------------------------------|-----|
| 6.4 Hazard Mitigation and Climate Change Adaptation..... | 99 |
| 6.5 Climate Change: Making a Difference..... | 99 |
| Appendix A Hurricane Shelters..... | 101 |
| Appendix B Emergency Contact Information..... | 105 |
| Appendix C Beach Management, Construction at the Coast, and Coastal Property Checklist..... | 109 |
| Appendix D Preparedness Checklists..... | 119 |
| Endnotes..... | 125 |
| Acronyms and Abbreviations..... | 131 |
| Useful Links and Resources..... | 133 |
| Notes..... | 137 |

Part 1

Introduction

Your home is your castle. It protects you and your family, as well as your worldly possessions, from the elements. For many, the home is also your major investment. Yet natural hazards such as tornados, hurricanes, tropical storms, floods, or high wind events can threaten your home, both inhabitants and contents. When a natural hazard occurs, the results can be devastating.

This handbook was created to help you prepare for a natural hazard so that risks to family and property may be reduced. While it is never possible to eliminate all damage from a natural hazard, you as a homeowner can take action and implement many small and cost-effective steps that could significantly lower your risk. Mother Nature can be intense. Your family and home deserve protection that only you can provide.

This handbook is divided into six parts:

- Part 1, the Introduction presents the purpose and layout of the handbook, and includes a discussion of common myths that may have prevented you from taking action in the past. There is also a summary of the content of this handbook in the form of ten action items. (See Part 1.2)
- Part 2 provides basic information on tornados, tropical storms, hurricanes, flooding, and wildfires that will allow you to make an educated decision about the steps to take to protect your family and property.
- Part 3 discusses in detail how to protect yourself and your family. Included in this section are the stock of essential emergency supplies, evacuation kit, evacuation planning, evacuation procedures, sheltering-in-place, and important information that the civil defense and emergency management agencies want you to know even before a warning siren goes off.
- Part 4 covers how you can protect your property.
- Part 5 discusses protecting your property with insurance.
- Part 6 addresses climate change and potential impacts from natural hazards.

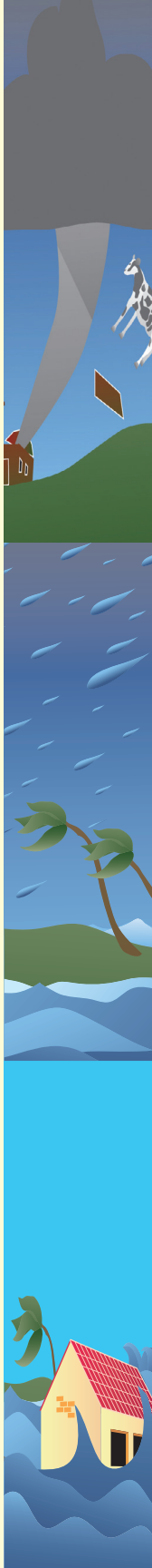



This handbook is available for free as a downloadable pdf file on the Storm Smart Coasts Florida website at www.fl.stormsmart.org/handbook.

This handbook will be updated on an as-needed basis as new information becomes available and feedback from the public is obtained. You can also contact Florida Division of Emergency Management, state or county civil defense and emergency management agencies by phone at the addresses and numbers provided (See Appendix B). In addition, many of the sponsors and participants of this handbook may have updated information on their own websites.

1.1 COMMON MYTHS AND REASONS TO PREPARE

You may be among the many homeowners in Florida who have not fully prepared for a natural hazard because of complacency caused by several myths. The most common myths appear as quotes below and are discussed in order to remove some of the major barriers to taking action and to encourage people to prepare.

1) **“I survived past natural disasters, so I am sufficiently prepared.”** Many people have the impression that if they survived one event, they are adequately prepared. Each event carries its unique set of threats that can be deadly and destructive. Planning and preparation can make a major difference. Remember the adage, “expect the best, but plan for the worst, and prepare to be surprised.”

2) **“If a hazard occurs, it won’t be that bad.”** When a tornado, hurricane or flood event occurs, the damage can be devastating. For example, although Katrina was only a Category 3 hurricane when she made landfall, over 1,800 people were killed in the Gulf of Mexico region, making Hurricane Katrina the third deadliest hurricane in U.S. history. More than 275,000 homes were lost as a result of the hurricane, 10 times as many as any other natural hazard in U.S. history.

3) **“A natural hazard can’t happen to me.”** Tropical storms, hurricanes and tornadoes are random events, and their path cannot be predicted. Because of the unique physical setting of Florida, bounded by the Gulf of Mexico and the Atlantic Ocean, no one is immune from the impact of these events. The best way to protect your life and property is to plan ahead BEFORE a storm forms then heed the warnings and advice of your local emergency management agency.

4) **“I don’t live near the coast, so I am safe.”** These natural disasters do not just impact the coast. Strong winds, heavy rain, tornadoes, and inland flooding can spread hundreds of miles from the coast, rivers, and lakes leaving extensive damage and death in their wake. Therefore, all homeowners should prepare, not just those along the coast.

5) **“Installing hurricane clips doesn’t guarantee there will be no damage after a hurricane, so I won’t bother.”** Even though someone may wear a seat belt, shoulder belt, and have an airbag, there is no guarantee that a person won’t be injured in a major auto accident. Yet most people recognize the importance of these safety devices in reducing risk and use them. Likewise, the measures discussed in this handbook could significantly reduce risk, although there are no guarantees.

6) **“If a natural hazard occurs, government will come to the rescue.”** Local government may not risk the lives of their emergency personnel to come out to rescue people who failed to heed evacuation orders. If you know there is a likelihood you may be impacted by a natural hazard, prepare to evacuate and follow the directions of local officials. If evacuation orders are optional and you decide to stay, be prepared to be self-sustaining for a **minimum** of 72 hours. After a disaster, residents may find that the government will not repair their damaged houses or even provide adequate compensation for property damage. It is up to you to plan properly, strengthen your house, and have the appropriate financial protections in place, such as insurance, if it is available. After a natural hazard, the government may also be overwhelmed by the number of people in need.

7) **“Hurricanes/tropical storms strike only during the official hurricane season of June 1 through November 30.”** These events sometime occur prior to or after the hurricane season. Since 1851, there have been 23 seasons where there have been storms prior to June 1, such as Tropical Storm Ana (2003) and Beryl (2012). They have appeared as late as January, with Hurricane Zeta (2006). With apparent climate variability and change, there may be more of these events outside the typical hurricane season. (See Part 6)

8) **“Even if a hazard occurs, there is nothing I can do.”** Fortunately, there are many small steps you can take to significantly reduce the risk of damage to life and property. While it is not possible to eliminate all risk or damage, these reasonable steps to plan and prepare can make a major difference and determine whether your house survives and just receives minor or no damage. Thus, the information in this handbook covers two major parts for preparation: (i) protecting yourself and your family, and (ii) protecting your property.

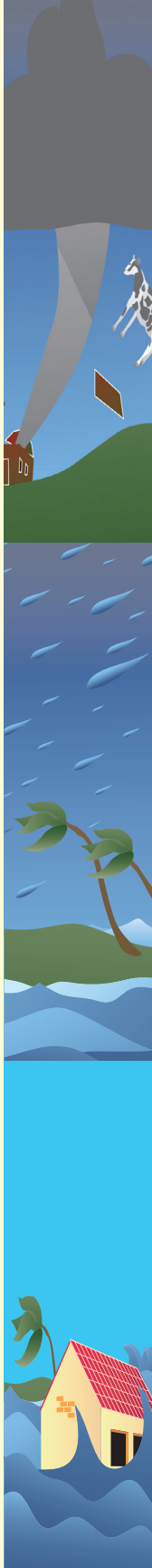



9) **“Strengthening my house is too expensive and not worth the effort.”** The following list discusses various ways to strengthen your house and the associated costs.

- Hurricane clips or window coverings can run on the order of a few thousand dollars. This alone offers significant protection.
- For minimal costs, the roof structure (trusses and rafters) for many houses can be strengthened with bracing.
- Strengthening your roof can be expensive if done by itself. However, if it is done when you replace your roof at the end of its normal life, the incremental cost is reasonable.
- Foundation upgrades can be expensive, but considering your house is probably your major investment, it could be worth the immediate cost.
- Strengthening your house can protect you from hurricanes. Ultimately, strengthening your house should be considered a home improvement that adds value to your house and is worth the effort, even without external incentives. The time and money spent to prepare your house is a very small fraction of the resources that may be needed if you fail to minimize damage when a natural hazard strikes.

Strengthening your house can protect you from tornados, hurricanes and floods. This is a double benefit. Many of these upgrades can be offset with insurance premium discounts. Ultimately, strengthening your house should be considered a home improvement that adds value to your house and is worth the effort, even without external incentives. The time and money spent to prepare your house is a very small fraction of the resources that may be needed if you fail to minimize damage when a natural hazard strikes. In addition, when a hazard such as a hurricane nears, evacuation to a shelter should be considered a last resort. There will be minimal supplies, the simplest of sanitary facilities, and little privacy. You will have to bring your own supplies, including bedding, medication, food and water. By preparing and strengthening your house, you are more likely to “weather the storm” in far more comfortable conditions and better take care of family members, including the elderly, those with special needs and pets.

By strengthening your house you protect your neighbors as well as yourself. A house that falls apart during a hurricane will create debris which can damage adjacent properties. You also help the emergency efforts of the local, state and federal governments by being able to assist other people instead of requiring help yourself.

10) **“My mobile home will be tied down and braced, so it is a safe place to ride out a storm.”** A mobile home is NEVER a safe place to weather a hurricane or tornado. Anyone living in a mobile home must evacuate, no matter what category of hurricane it is. According to the National Hurricane Center, no mobile or manufactured home – no matter how new it is – can be a safe shelter from hurricane-force winds. While never a safe place to ride out a storm, tie-downs and straps can prevent your mobile home from coming loose and causing damage.

1.2 TEN THINGS YOU CAN DO TO PREPARE

As covered in later parts of this handbook, here are ten things you can do to prepare that will provide greater protection to your family and your property.

1) Gather your emergency supplies. You can gather emergency supplies in your house now. Check and restock each month so that the supplies are complete, not outdated or used. Avoid rushing to a store during an emergency to gather your supplies. There will be long lines and empty shelves. You will add to the crowd and confusion. The good news is many items you need are probably already in your home. (See Part 3)

2) Create a separate evacuation plan for natural events, such as hurricanes/tropical storms, tornadoes, floods and wildfires. They are all different. For a hurricane/tropical storm, your plan may include sheltering in your house if it is sufficiently strong (see #5) and outside the evacuation zone. If you can't use your house, use a suitable alternative structure (a friend's or relative's house) or a shelter that is officially open (listen to local radio and television). (See Part 3)

For a tornado, listen to NOAA radio or commercial radio for latest information. Be alert for changing weather conditions. You may not have time to evacuate to a designated shelter; your warning may be a tornado siren. If you hear the siren, take immediate safety precautions in your home. Go to your basement, storm cellar or center of an interior room on lowest level. Get under a sturdy table and use your arms to protect your head and neck (See Part 3).

For a flood, evacuate to high ground outside the evacuation zone if: (i) there is a flood strong enough so that you cannot stand, or (ii) you are instructed by local radio and television to evacuate. Once you have evacuated, the wait may be many hours. Discuss and practice drills of your evacuation plan with your family each year (See Part 3).





3) Know your property and take appropriate action. Look at where you are located. If the land floods, consider flood insurance. If trees overhang your house, consider trimming or cutting the branches overhead which may damage your house in a storm. If the property has a high structural profile, it may be especially susceptible to wind damage during a tropical storm or hurricane. (See Part 4)

4) Know your house and take appropriate action. When was your house built? Does it have connectors to tie the roof to the wall or the wall to the foundation? When will you need to re-roof? Look at your blueprints. They may be available from your homebuilder, your local building department, or your architect. (See Part 4)

5) Strengthen your house. A house built after the early to mid-1990s should have hurricane clips to tie the roof to the wall and strong connectors from the wall to the foundation. If your house was built before then, you can still retrofit at a reasonable cost. All households should consider the many options now available to protect your windows, garage, and doors. You can also strengthen your roof when it is time to re-roof. The steps a homeowner can take will vary with each house, but for most homeowners, there are a few steps that can make a significant difference. (See Part 4)

6) Utilize the State of Florida’s Hazard Mitigation Grant Program. They have developed a worksheet for Safe Room construction (www.floridadisaster.org/mitigation/Hazard/Documents/Tornado_Worksheet.pdf). Under contract with the Department of Community Affairs, Dr. Nur Yazdani, Ph.D., P.E., of the Florida A&M - Florida State University, College of Engineering, has developed this guide to help homeowners build a “retrofit room” in their existing houses. The “retrofit room” is designed to provide an area within the house that is resistant to wind speeds up to 140mph, which is the equivalent to either a Category 4 hurricane or an F2 tornado. (See Part 4).

7) Insurance. Don’t gamble with your house. Obtain adequate hurricane, and flood insurance if you are in a flood prone area, and it is available. (See Part 5)

8) Take advantage of potential discounts for your hurricane insurance premiums.

Coverage may vary among insurance companies so call your insurance agent to find out about discounts that may be available. Significant discounts may be provided for reducing the risk to your house with window protection, roof-to-wall tie downs (hurricane clips), and wall-to-foundation tie downs. (See Part 5)

9) **Finance creatively.** Consider efforts to strengthen your house as an important home improvement project. Most projects are not that expensive. For the more costly ones, a small home improvement loan, and potential discounts from hurricane insurance premiums, may make these projects within reach. It is a great investment to strengthen your house and provide more protection to your family. (See Part 4)

10) **Seek the assistance of a qualified, licensed architect, structural engineer, or contractor.** This handbook covers work that you may be able to do yourself. If you cannot do the work, seek qualified assistance through trusted references from friends and family, the Structural Engineers Association, your county civil defense and emergency management agencies, or the contractors associations for your island. Even if you do the work yourself, it is always best to seek professional advice for initial guidance since every house is a little different. (See Part 4)

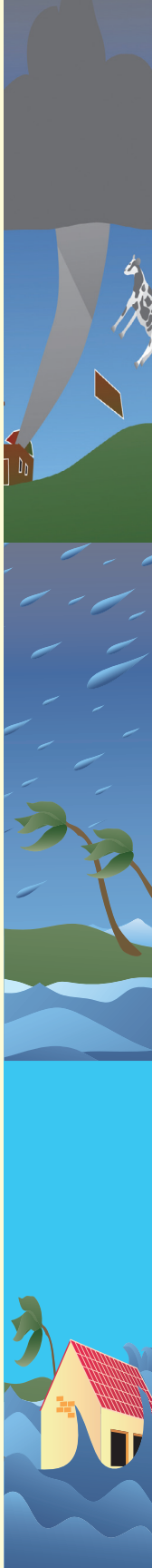

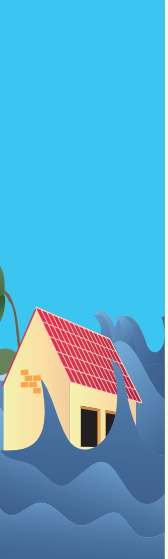
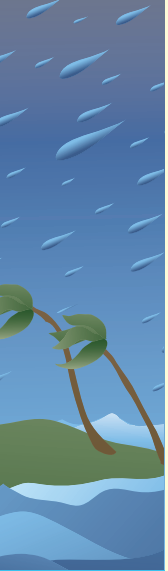

Part 2

Natural Hazards: An Overview for Homeowners

In Florida many different types of natural hazards can occur, such as flooding, fire, tornados, coastal erosion, sea-level rise, subsidence, tropical storms, and hurricanes. This handbook concentrates on the most potentially devastating hazards in terms of loss of life and property damage: tornados, tropical storms, hurricanes, flooding, and wildfires.

Preparing for the larger, intense weather hazards (tropical storms, hurricanes, tornados) and flooding events will often offer protection from smaller, more frequent events. Included here is basic information that may play a role in how you as a homeowner may prepare for larger hazard events.

2.1 TORNADO HAZARDS

Tornados are one of nature's most violent storms (Figure 2-1). Spawned from powerful thunderstorms, tornados can cause fatalities and devastate a neighborhood in seconds. A tornado appears as a rotating, funnel-shaped cloud that extends from a thunderstorm to the ground with whirling winds that can exceed 200 miles per hour (mph). These violent winds are what make tornados so deadly - they can uproot and snap trees, down power lines, move or pick up cars and trucks, and destroy homes. Wind speeds may exceed those found in the most intense hurricane. Damage paths can be in excess of one mile wide and 50 miles long. Tornados that form over a body of water are called waterspouts.¹

Large tornados can be weak; small tornados can be violent. The size of a tornado is not necessarily an indication of its intensity. The Fujita (F) Scale was originally developed by Dr. Tetsuya Theodore Fujita in 1971 to estimate tornado wind speeds based on damage left behind by a tornado. An Enhanced Fujita (EF) Scale, developed by a forum of nationally renowned meteorologists and wind engineers, makes improvements to and replaces the original F scale. The scale ranges from EF0 (65-85 mph) to EF5 (200+ mph).



Figure 2-1: Tornado (Source: NOAA)

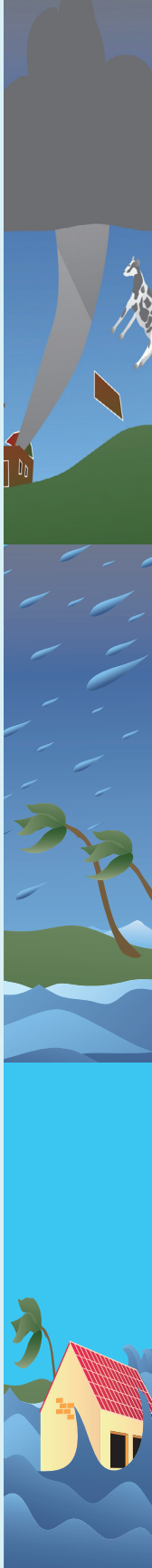

Every state is at some risk but compared with other States. Florida ranks number 4 for frequency of Tornadoes, 19 for number of deaths, 12 for injuries, and 18 for cost of damages. When these statistics are compared to other states by the frequency per square mile, Florida ranks number 1 for the frequency of tornadoes, number 20 for fatalities, number 13 for injuries per area and number 17 for costs per area.²

Table 2-1: The EF Scale³

| EF-Scale Number | Class | Wind Speed | Description ⁴ |
|-----------------|---------|-------------|-------------------------------------------------------------------------------------------------------------------------------------------------------------------------------------------------------------------------------------------------------|
| EF0 | Weak | 65-85 mph | Gale: Some damage to chimneys; breaks branches off trees; damages sign boards. |
| EF1 | Weak | 86-110 mph | Moderate: Peels surface off roofs; mobile homes pushed off foundations or overturned; moving autos pushed off the roads; attached garages may be destroyed. |
| EF2 | Strong | 111-135 mph | Significant: Considerable damage. Roofs torn off frame houses; mobile homes demolished; boxcars pushed over; large trees snapped or uprooted; light object missiles generated. |
| EF3 | Strong | 136-165 mph | Severe: Roof and some walls torn off well constructed houses; trains overturned; most trees in forest uprooted. |
| EF4 | Violent | 166-200 mph | Devastating: Well-constructed houses leveled; structures with weak foundations blown off some distance; cars thrown and large missiles generated. |
| EF5 | Violent | >200 mph | Incredible: Strong frame houses lifted off foundations and carried considerable distances to disintegrate; automobile sized missiles fly through the air in excess of 100 meters; trees debarked; steel reinforced concrete structures badly damaged. |

(Source: NOAA's National Weather Service - Thunderstorm Hazards, Tornadoes and the Fujita Scale project)

Tornadoes can form any time of the year in Florida, most occur in the spring and summer months. In the spring (February – May), they usually are created from severe super cells along a squall line ahead of a cold front. These can also occur in the fall and winter months (October – January). The summer tornado season (June –September) general occur along strong sea breeze boundary collisions, as well as from hurricane events.⁵

Before a tornado hits, the wind may die down and the air may become very still. A cloud of debris can mark the location of a tornado even if a funnel is not visible. It is not uncommon to see clear, sunlit skies behind a tornado. The average forward speed of a tornado is 30 mph, but may vary from stationary to 70 mph.

2.2 INTENSE TROPICAL STORM HAZARDS

2.2.1 Tropical Storms

A tropical storm is an intense weather system characterized by a low atmospheric pressure center surrounded by a spiral arrangement of thunderstorms that produce strong winds and heavy rains. The winds blow in a counter clockwise flow at speeds ranging from 39 to 73 mph. These tropical storms have the ability to develop into a hurricane once winds exceed 74 mph consistently; thus they are monitored, tracked and named by the National Weather Service (NWS).

Also monitored are “tropical depressions” that are organized systems of persistent clouds and thunderstorms with similar closed low-level circulation patterns with sustained winds of 38 mph or less. Even a tropical storm or tropical depression can cause substantial damage.

Individuals should not downplay these storms, since they can produce strong waves and storm surges that can result in shore erosion and coastal flooding. They also produce heavy rains that can produce heavy inland flooding. For example, in 2012 Tropical Storm Debby had a major impact from Southwest Florida into the Panhandle. Although it only had maximum sustained winds of 65 mph, it caused flooding to low-lying neighborhoods in St. Petersburg, left more than 35,000 people without power, and closed the Skyline Bridge that spans Tampa Bay. Remaining stationery in the Florida panhandle, it dumped more than 20 inches of rain that flooded the downtown of Live Oak, Florida, destroying many commercial and residential buildings and causing a number of sinkholes to be formed (Figure 2-2).

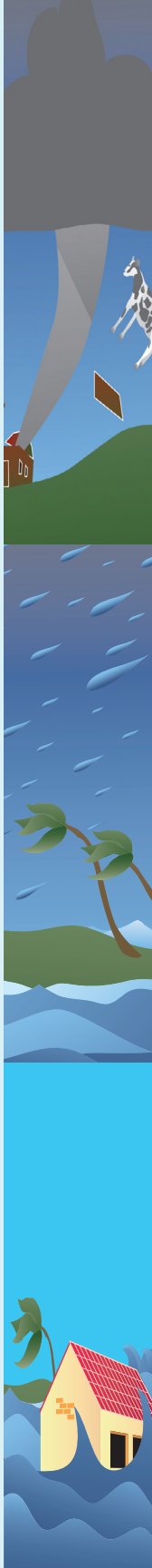



Figure 2-2: Flooded streets in Live Oak, Florida following Tropical Storm Debby in June of 2012
(Source: Suwannee Democrat)

2.2.2 Hurricanes

A hurricane is an intense tropical weather system with a well-defined counter clockwise circulation pattern and sustained winds of 74 mph or more. Florida is highly vulnerable to hurricanes due to its peninsular shape, bordering both the Gulf of Mexico and Atlantic Ocean. It has been impacted by about 500 hurricanes since records were kept. Since 1851, thirty-eight Category 3 or larger hurricanes have crossed across Florida; this is more than any other U.S. state. Three of the top five costliest hurricanes in U.S. history impacted Florida; Hurricane Andrew (1992), Hurricane Charley (2004) and Hurricane Ivan (2004).

Hurricane strength is often given in categories using the Saffir-Simpson Hurricane Scale, which rates hurricanes from 1 to 5 based on the intensity of the sustained winds (Table 2-2). Earlier versions of this scale incorporated central pressure and storm surge as components of the categories. The central pressure was used during the 1970s and 1980s as a proxy for the winds as accurate wind speed intensity measurements from aircraft reconnaissance were not routinely available for hurricanes until 1990. Storm surge was also quantified by category in the earliest published versions of the scale dating back to 1972. However, hurricane size, depth of near-shore waters, topography and the hurricane's forward speed and angle to the coast also affect the surge that is produced. For example, the very large Hurricane Ike (with hurricane force winds extending as much as 125 miles from the center) in 2008 made landfall in Texas as a Category 2 hurricane and had peak storm surge values of about 20 feet. In contrast, tiny Hurricane Charley (with hurricane force winds extending at most 25 miles from the center) struck Florida in 2004 as a Category 4 hurricane and produced a peak storm surge of only about 7 feet. These storm surge values were substantially outside of the ranges suggested in the original scale.

Table 2-2: 2010 Saffir-Simpson Hurricane Wind Scale⁶

| Category | Sustained Wind Speed | Damage Expected |
|----------|----------------------|-----------------------------------------------------------------------------------------------------------------------------------------------------------------------------------------------------------------------------------------------------------------------------------------------------------------------------------------------------------------------------------------------------------------------------------------------------------------------------------------------|
| 1 | 74-95 mph | No real damage to sturdy buildings; damage to poorly constructed older homes and those with corrugated metal or temporary units; some tree damage. Examples: Hurricanes Danny (1991) and Gustav (2008). |
| 2 | 96-110 mph | Some damage to building roofs, doors, and windows; considerable damage to poorly constructed or termite infested homes; trees blown down, especially those that are shallow rotted. Example Hurricane Georges (1998) |
| 3 | 111-130 mph | Some structural damage to well built small residences; extensive damage to termite infested buildings; large trees blown down or snap in half. Examples: Hurricanes Frederic (1979), Elena (1985) and Katrina (2005). |
| 4 | 131-155 mph | Extensive damage to non-concrete structures; complete failure of many roofs, windows, and doors, especially unprotected, non-reinforced ones; many well built wooden and metal structures severely damaged or destroyed; considerable glass failures due to flying debris and explosive pressure forces created by extreme wind gusts; complete disintegration of structures of lighter material; many large trees blown down; major erosion on beach area. Example: Hurricane Charley (2004) |
| 5 | >156 mph | Extensive or total destruction of non-concrete reinforced structures; some structural damage to concrete buildings from debris such as cars or appliances; many well constructed storm shutters ripped off from structures; many large trees blown down; flooding and major damage to lower floors near the shoreline. Examples: Hurricanes Camille (1969) and Andrew (1992). |

(Source: NOAA's National Weather Service website The Saffir-Simpson Hurricane Wind Scale)

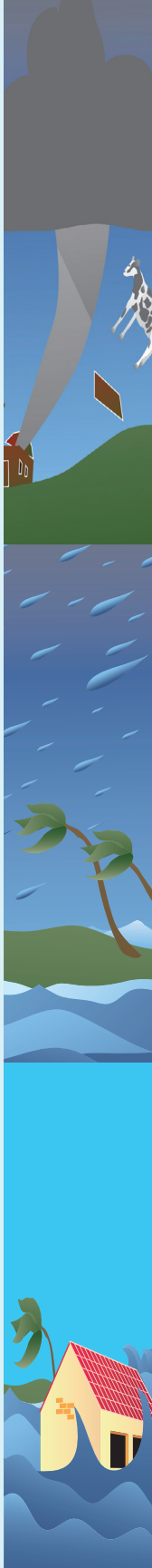

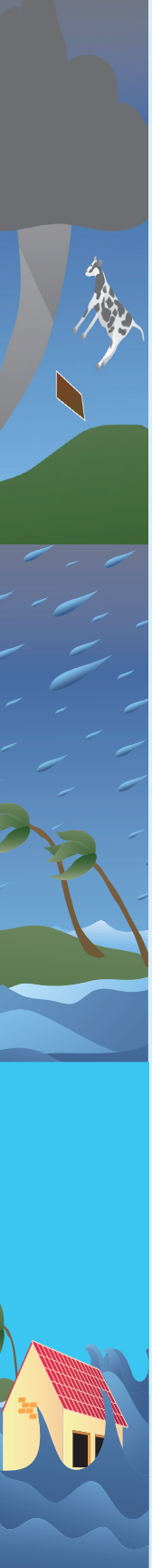

Thus to help reduce public confusion about the impacts associated with the various hurricane categories as well as to provide a more scientifically defensible scale, the storm surge ranges, flooding impact and central pressure statements have been removed from the scale and only peak winds are employed in the revised version known as the Saffir-Simpson Hurricane Wind Scale. It is important to note that the Saffir-Simpson Scale only illustrates the “sustained winds” of a hurricane. Wind gusts can reach up to 135 mph for a Category 2 storm and up to 160 mph for a Category 3 storm.

During a hurricane, there is a triple threat of damage from high winds, storm surge and flooding associated with heavy rains (Figure 2-3). In a hurricane, the winds rapidly increase in strength from the weakest on the outer edge to the strongest near the eye. Hurricane winds are most intense around the eyewall. This area is generally 15 to 20 miles wide and contains the most intense rainfall. Hurricanes also produce tornados which add to their destructive power.

Storm surge is a large dome of water, a rise in coastal sea level above the usual tide level, often 50 to 100 miles wide that sweeps ashore near where a hurricane strikes land and typically accounts for 90 percent of storm-related deaths. A surge of 10 feet or more can cause severe flooding far inland and cause severe damage along the coast when wave action adds destructive power and height to the basic surge elevation, particularly, when storm surge coincides with high tide (Figures 2-4 and 2-5). For example, Hurricane Katrina in 2005 generated a U.S. record storm surge of 28.1 feet and devastated the coasts of Louisiana, Mississippi and Alabama, with flooding occurring more than several miles inland.

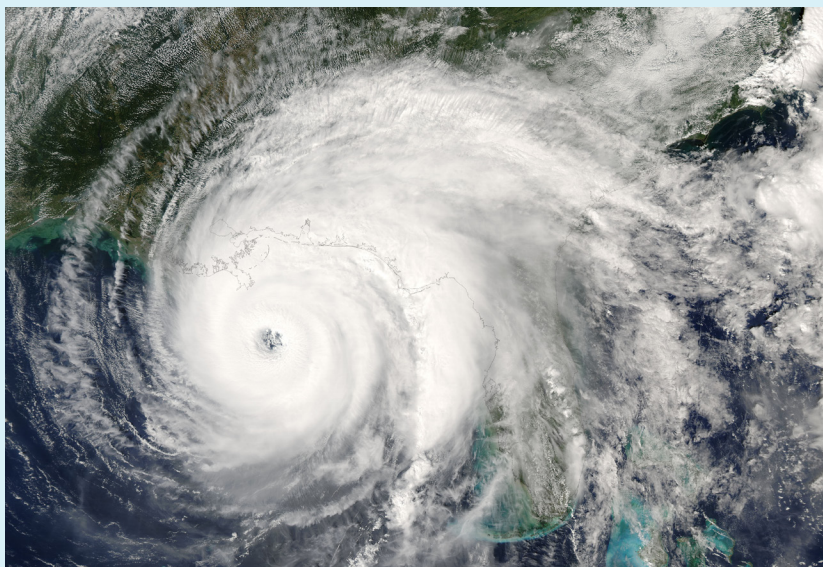

Figure 2-3: NOAA satellite image of Hurricane Ivan in September of 2004. The bands of strong winds, rain and storm surge spread from Louisiana to Florida

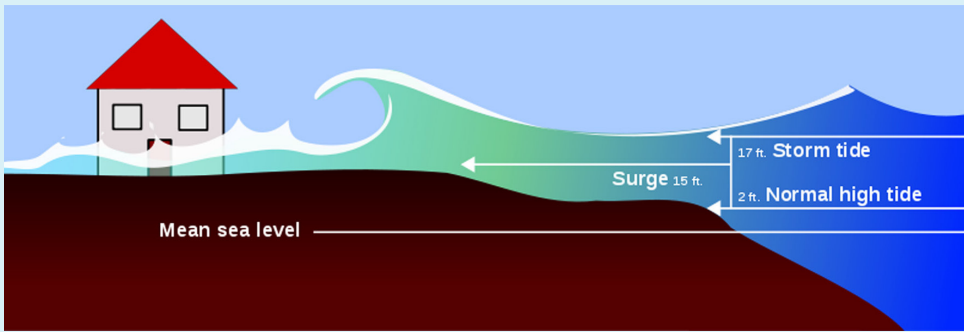

Figure 24. Storm surge depiction

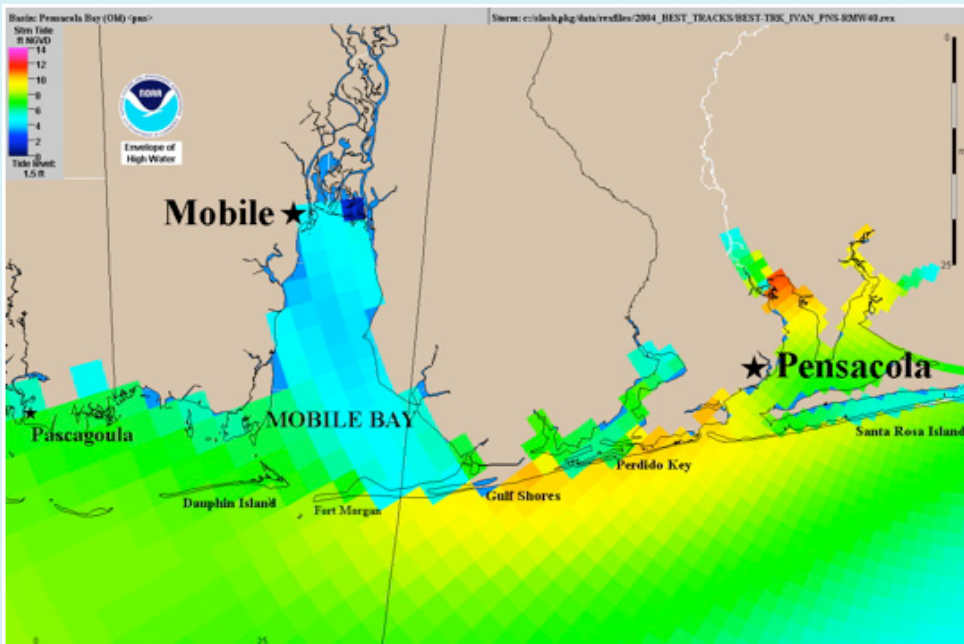

Figure 2-5. NOAA model depicting storm tide experienced by the northern Gulf of Mexico during Ivan in September 2004

Rainfall totals of 10 inches or more are not uncommon when a tropical storm or hurricane moves across a coastal location. Torrential rains continue in upland areas long after the high winds of a hurricane diminish. Rainfall totals of this magnitude can result in destructive flash flooding near streams, bayous and rivers. Flooding also causes extensive property and agricultural losses.

2.3 FLOOD HAZARDS

Flooding in Florida is probably the most common natural hazard in the state, if not the most intense. Flooding can be caused not only by a hurricane, but also by a tropical storm, tropical depression, or other weather system that produces heavy rain. Flooding can build up gradually over a period of days, or suddenly in a few minutes (this is commonly known as a flash flood). In addition, coastal flooding and wave inundation can be produced by a hurricane or high-surf event with waves generated by local storms. Flooding can be associated with living near a body of water such as the ocean or a stream, river, or reservoir.

Excluding Alaska, Florida has longest coastline of any state in the United States. The coastline extends more than 1,350 miles, with tidal shorelines that cover more than 7,800 miles. It is the only state that borders both the Gulf of Mexico and Atlantic Ocean. Much of the state is at or near sea level. With approximately 80% of its 18 million residents living along Florida's coasts, the population is very vulnerable to coastal flooding.

You can determine if you are in a high-risk flood area by looking at the Federal Emergency Management Agency's (FEMA) flood insurance rate maps. These maps show what areas are susceptible to flooding and high velocity wave action (for those near coastal areas). Copies of the maps can be obtained digitally at www.msc.fema.gov, and may also be available for viewing at your city or county building departments.

Even if you are not in an official flood zone, you may be at risk from flooding. Go to the following website and type in your street address to determine a very general estimate of the flood risk for your property: www.floodsmart.gov.

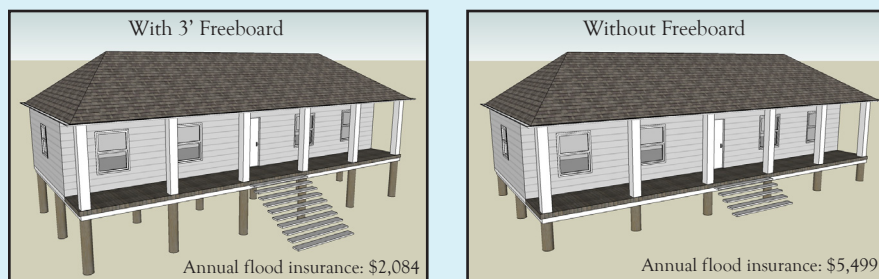

Figure 2-6. In this example, adding a small amount of height has very little effect on the look of a home, but resulted in a substantial flood insurance savings⁷
(Source: Storm Smart Coasts)

A good way to determine the risk of flooding for your house is to observe and study your property. Even inland properties may be susceptible to flooding if there is poor localized drainage or if recent development has altered the ability for water to drain out of your area. If your property floods during small rain events, then the problem will be greater during a storm or hurricane. You can protect yourself by improving the local drainage, making your house resistant to floods and purchasing flood insurance. You do not need to be in an official flood zone to obtain flood insurance.

For those located within a flood zone, elevating a building's lowest floor above predicted flood elevations by a small additional height (known as "freeboard") has very little effect on the look of a home, yet it can lead to substantial reductions in damages caused by flooding as well as reductions in flood insurance (Figure 2-6). Consult with your local floodplain manager to determine how much freeboard (if any) is needed for your property for flood insurance savings.

Even if you are not in a flood zone, you should consider purchasing flood insurance. The rates for properties outside declared flood zones are very affordable and are "priceless" if a flood event should occur.

2.4 WILDFIRE HAZARDS

Wildfire is defined by the Florida Forest Service (FFS) as any fire that does not meet management objectives or is out of control. Wildfires occur in Florida every year and are part of the natural cycle of Florida's fire-adapted ecosystems. Many of these fires are quickly suppressed before they can damage or destroy property, homes and lives.

Land managers and Florida Forest Service firefighters use prescribed or controlled fires to mimic the natural benefits that wildfires provide to properties both private and public across the state. Prescribed burns help in reducing the amount of flammable vegetation in an area which in turn lessens the intensity of a wildfire that may occur in that same area and allows for the opportunity to suppress the fire while it is small and easier to control.

There have been 141,230 wildfires that burned 5 million acres in the last 30 years in Florida. Lightning strikes are responsible for 30 - 35% of the wildfires in the state each year leaving 70 - 75% of wildfires as human caused. Arson and escaped debris burning are the top two human causes of wildfires in Florida.

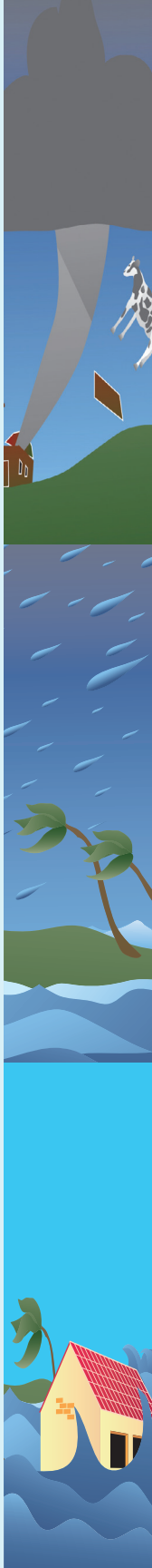

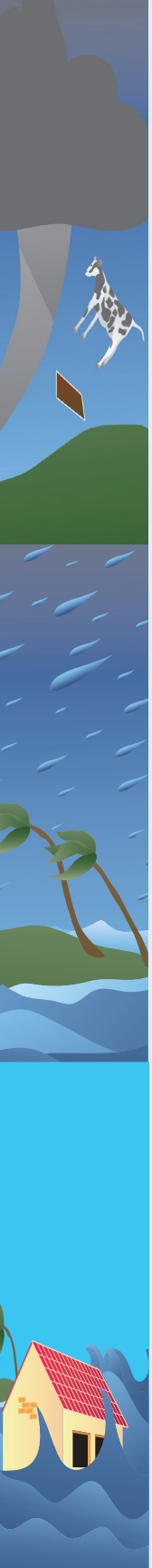

Continued development of housing and infrastructure within wildland areas and forestlands presents a wildfire hazard that will continue to escalate as residential development continues to encroach on the natural areas. The area where structures and other human developments meet or intermingle with wildlands or vegetative fuels is called the Wildland Urban Interface. Currently, 80% of all wildfires occur within 1 mile of Wildland Urban Interface areas. Because of this fact, wildfire prevention and public awareness campaigns have been increased significantly to reduce the number of human caused wildfires in Florida.

Florida's long growing season, ample sunshine, and high annual rainfall produces large amounts of vegetation each year. The Florida Forest Service and other state agencies have worked for several years to mitigate this wildfire risk. Mitigation measures have included using prescribed fire, mechanical fuel reduction such as mowing or chopping, and public education programs that teach citizen responsibility to reduce their own vulnerability through programs like "Firewise" and "Ready, Set, Go."

Building retrofit and fire resistant landscaping, research and risk assessment, planning policies and regulations will all assist in creating more disaster resistant communities. The Florida Forest Service intends to continue to implement coordinated strategies to help reduce the potential for injury, loss of life, and negative impact to homes, businesses and public infrastructure.

Part 3

Protecting Yourself and Your Family

This part of the handbook covers the topic of protecting yourself and your family from natural hazards. In particular, it is important that your household has a stock of emergency supplies, an evacuation kit, and evacuation plans for a tornado, flooding event, and hurricane since each will differ depending on the nature of the threat. You should discuss and practice the plan with your family once a year, or whenever there is a major lifestyle change (for example, when a member of the family goes to a new school or is working in a different location).

3.1 EMERGENCY SUPPLIES

A general rule of thumb when preparing for a hazard event is to remember to be self-sustaining for a minimum of the first 72 hours (3 days) after a hazard event. Due to a lack of access or availability, basic supplies may be unobtainable. Therefore, a stock of emergency supplies will be helpful during a major event like a hurricane or tropical storm, as well as for a minor event like a simple power outage. In a major disaster, you may be without access to power and water for several weeks, so it is better to over-plan rather than under-plan in ensuring you have adequate supplies. For example, on August 13, 2004, Hurricane Charlie made land fall, the first of four major hurricanes to sweep across parts of Florida over a six week period. Many areas of Florida (both rural and urban) were without power or potable water for several weeks. Another example is that following Hurricane Katrina in August of 2005, many parts of the Mississippi, Alabama, and Louisiana were without power for weeks.

Your emergency supplies should be gathered as soon as possible and checked monthly so that they are complete, unused, and fresh (mark and check expiration dates). Old food should be used or discarded and replaced with fresh supplies. Do not keep expired supplies. Your supplies should include at least the following:

- Portable radio, flashlight, and extra batteries (or flashlight and radio with hand-crank rechargeable batteries);
- First-aid kit;
- List and supply of special medications (prescriptions and others);

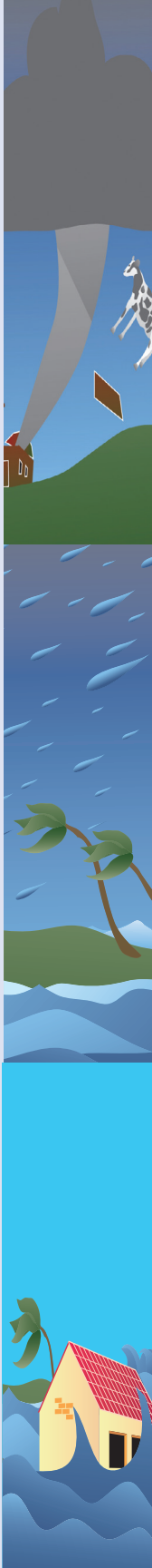

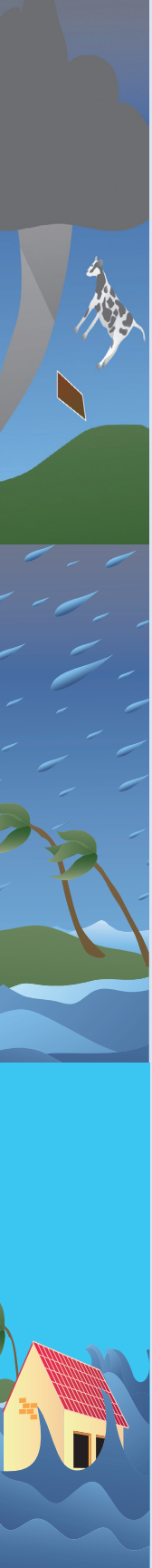

- Five to seven day supply of nonperishable foods. Ideal foods are those that do not need refrigeration, are low in salt, and do not require cooking (e.g. canned fruits, peanut butter, jam, low-salt crackers, cereals, dried fruit, canned soups or meats, juices, and non-fat dry milk);
- Include any special foods for those with dietary restrictions, and baby food and formula if you have infants in the household;
- Store your food in tight, pest-resistant containers in a cool, dark place;
- After a power outage, refrigerated food will stay cold longer if you keep the refrigerator door closed. Food in refrigerator should generally be eaten within 4 hours; food in the freezer may remain safe for 1-2 days. But when in doubt if food is safe to eat, throw it out;
- Hibachi with charcoal, camping stove with fuel, or barbeque grill with propane. (Do not use these items indoors or in an area with no ventilation. Follow all manufacturer instructions);
- Manual can opener;
- Matches or lighter;
- Disposable plates and kitchen utensils;
- Five to seven day supply of water. A reasonable estimate is a minimum of one gallon per person per day. Three gallons per person per day will give you enough for drinking, cooking, and personal hygiene needs. It is important to have available good water containers for any water-interruption situations. Four- to six-gallon water containers are readily available in stores. Remember to store water for toilet use (in bathtubs, rubbish containers, washing machines, water heater, etc.) Store your water in a cool, dark place. Try to replace your water at least once every six months;
- Pet supplies (food, leash, medications).

Some additional items you may wish to add to your stock include (Figure 3-1):

- Sanitary supplies, portable toilet, or porta potty;
- Spare cash. Automated teller machines require electricity to operate and may not be available or accessible for weeks;

- Waterproof plastic sheeting or blue tarp, with string or rope;
- Cell phone and a hardwire single line phone. Cell phone networks maybe overloaded during times of natural hazards. Cordless phones with a base station will not work without electricity. If you need to rely on cordless phones, get an alternate source of power. Otherwise, have an old-fashioned corded phone. Use your phone during a natural hazard only in an emergency;
- Bedding and clothing for each person;
- Blankets and towels;
- Rain jackets and pants;
- Sunscreen and bug repellent;
- Baby supplies (diapers, food, medication);
- Toothbrush, toothpaste, soap, shampoo, cleanser, bleach, trash bags, towelletes, water-free hand disinfectant;
- Copies of important documents- driver license, social security card, proof of residence, insurance policies, wills, deeds, birth and marriage certificates, tax records, medical records, family pictures, etc.;
- Alternate power supplies. During an emergency or power outage, alternative sources of power may be needed (among these are generators, inverters, power stations, and battery chargers). See Part 4 for descriptions of alternative power sources that may supplement your emergency supplies. Note that if you are taking shelter in your home (outside the evacuation zone and in a strong dwelling [Part 4]), you may wish to have more than five to seven days of supplies. There is always the possibility that a major storm or hurricane could disrupt the supply line of goods. If the space is available and your house is protected, stocking up for a two week period is prudent. Gather the supplies over a period of time versus during an emergency, when you could face or contribute to shortages.

Figure 3-1: Items to be included in emergency supply kit

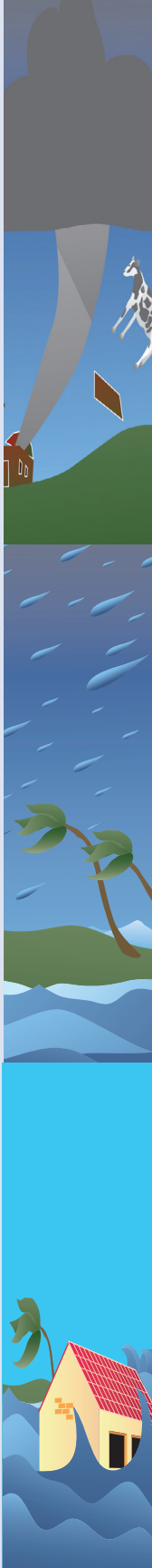

3.2 EVACUATION KIT

The evacuation kit differs from your stock of emergency supplies since the kit is what you will take if you need to leave your house in an emergency. Your evacuation kit should be prepared as soon as possible and can be checked before the beginning of hurricane season, which runs June 1 to November 30. The components of the kit should be stored in one place, perhaps in a duffle bag or backpack, so that it is ready to go at a moment's notice. The kit is primarily for evacuation during a hurricane, although it could be used for other situations (including severe flooding, fires, police situation, etc.).

The following evacuation kit was compiled with the input of all county civil defense and emergency management agencies, and universities:

- Cash (banks and ATMs may not be available for an extended period of time);
- Minimum of 1 gallon potable water per day per person (plan for three days);
- Personal items and family needs, such as 2-week supply of daily prescription medications, a minimum of a 3-day supply of nonperishable food and any special dietary foods, can opener, infant formula, and diapers; prescription eyewear and personal hygiene items such as waterless cleaner, toothbrush/ toothpaste, toilet paper roll;
- List of any required medications, special medical information, Medical Care Directives, health insurance card and policies, bank account numbers, personal identification, and other important documents (best kept in a waterproof envelope {See Part 5.5});
- First-aid kit;
- Flashlights, batteries, and spare bulbs, portable radio with spare batteries;
- Change of clothes, rain gear, sturdy shoes, a towel;
- Pillows, blankets, and folding mattresses/air mattresses;
- Toys, games and books;
- Any special items for babies/children, seniors or people with disabilities;
- Have a pet care plan (many shelters will not take pets).

The American Red Cross recommends that the evacuation kit should contain supplies for five to seven days. Should the supply chain be disrupted (because of, for example, a damaged airport or warehouses), you will be better off than others who do not have adequate supplies. There is a fine line between bringing too many supplies that overload the limited shelter space and not bringing enough. However, if you go to a shelter, keep in mind that there will be limited space, so bring only what is recommended unless you are instructed otherwise by your civil defense or emergency management agencies. Be sure to include activity materials (i.e. books, games) to help you and your family pass the time and be distracted from the stress of a natural disaster while in the shelter.

3.3 EVACUATION PLANNING

In Florida, it is important for families to plan for a variety of disasters that may include severe flooding events, wild fires or hurricanes. When you put your evacuation plan together, here are some things to consider:

Stay alert, stay calm, and be informed (tuning in to local radio and television is important). Create an evacuation plan and review it with your family every year.

Evacuation procedures for a hurricane will differ from those of a flooding event or wild fires. (See section 3.5 for evacuation procedures for a hurricane). However, you should consider a plan for all. In a hurricane, you must protect yourself from strong winds, torrential rain, and coastal inundation. In a flood, you must protect yourself from inundation of rising water. In a wild fire, you need to protect yourself from the approaching fire, and plan for a quick, safe evacuation route.

Any emergency plan should include a list of potential evacuation routes. The Florida Division of Emergency Management publishes county-wide evaluation routes at the following website: floridadisaster.org/PublicMapping/index.htm. During an emergency, your local emergency management program should always be consulted regarding evacuation orders and routes.

You should also consider location of area and regional shelters. In Florida, a list of general emergency shelters by counties, can be found at: www.floridadisaster.org/shelters.

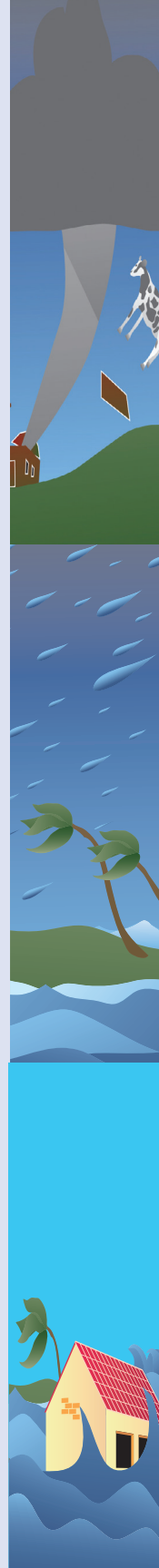



Emergency Communications

In a disaster, normal electronic communications may not be possible, and you may become separated from your family members since members may be at school, work or home when the disaster occurs. You should develop an emergency communication plan with your family if you are separated. Identify a meeting place that is a safe distance from your home and that is a familiar, well-identifiable location to all of you. A disaster such as a hurricane, tornado or fire may destroy many of the surrounding landmarks or buildings. Identify a location outside your neighborhood in case you cannot return home. Have an out-of-state contact and “check-in” contact for everyone to call. Sometimes it is easier to make a long distance call than a local call in a disaster situation.

3.3.1 Key Definitions

Advisory. Message, generally at six hour intervals, updating information on tropical storm or hurricane, including watches and warnings whenever they are in effect. (See below). A special advisory is given any time there is a significant change in weather conditions or change in warnings.

Hurricane Watch. Hurricane conditions with winds of 74 mph or more are possible in the specified area of the Watch, usually within 36 hours. During a Watch, prepare your home and review your plan for evacuation in case a Hurricane Warning is issued. As discussed earlier in this section, preliminary preparations should begin even before a Watch has been issued.

Hurricane Warning. Hurricane conditions with winds of 74 mph or more are expected in the specified area of the Warning, usually within 24 hours. Complete storm preparations and leave the threatened area if directed by local officials.

Hurricane. A tropical storm with winds exceeding 74 mph.

Storm Surge. A rise in coastal sea level above the usual tide level as a hurricane or other intense tropical storm moves over water, causing flooding when the storm comes ashore.

Tropical Storm Warning. Warning of conditions with non-cyclonic winds between 55 to 73 mph expected.

Tropical Storm. A counterclockwise circulation of clouds and winds between 39 to 73 mph. The storm is assigned a name and tracked by the National Weather Service.

Flash Flood or Flood Watch. Issued when flash flooding or flooding is possible within the designated watch area. Be prepared to move to higher ground; listen to NOAA Weather Radio, local radio, or local television for information.

Flash Flood or Flood Warning. Issued when flash flooding or flooding has been reported or is imminent. Take necessary precautions at once. If advised to evacuate to higher ground, do so immediately.

3.3.2 Emergency Alert System

The Emergency Alert System (EAS) is the official source of natural hazard information and instruction in the state. This information can originate from county, state, or federal agencies. For example, the EAS Network could disseminate warnings and/or instructions from the governor's office during threats or emergencies affecting one or more counties within the state. The statewide network may also be activated by the National Weather Service Forecast Office to disseminate weather- or tsunami-related watches or warnings.

If a siren sounds, turn on your radio. Some radios with the NOAA weather radio band turn on automatically when an emergency broadcast through the EAS is announced. This could be useful for homeowners along the coast. NOAA Weather Radio All Hazards (NWR) is a nationwide network of radio stations broadcasting continuous weather information directly from the nearest National Weather Service Office. NWR broadcasts official Weather Service warnings, watches, forecasts and other hazard information 24 hours a day, 7 days a week. A list of NWR stations in Florida can be found at the following website: www.nws.noaa.gov/nwr/stations.php?State=FL. Table 3-1 lists the participating primary stations.

Local radio stations voluntarily agreed to participate in the EAS system. Additional information is also be available on local and cable television.

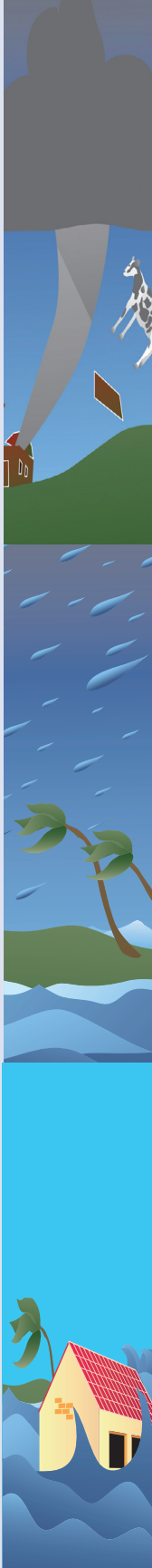

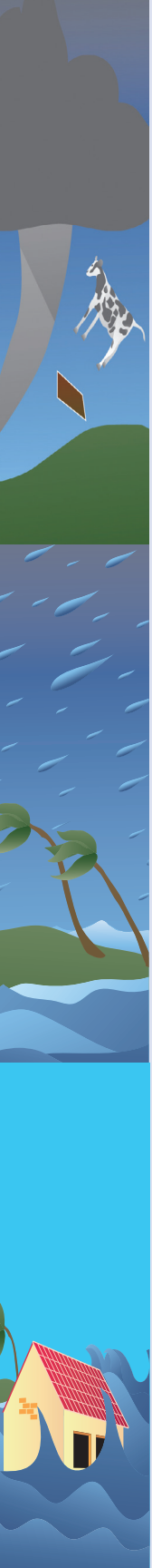

Table 3-1. Participating Radio Stations Broadcasting Emergency Situations
(Local Primary Stations only)⁸

| City | Station | City | Station |
|-------------------|----------|-------------------|----------|
| Altamonte Springs | 88.3 FM | Altamonte Springs | 88.7 FM |
| Altamonte Springs | 91.1 FM | Altamonte Springs | 91.7 FM |
| Big Pine Key | 104.1 FM | Bonita Springs | 104.7 FM |
| Coral Gables | 98.3 FM | Coral Gables | 107.5 FM |
| Coral Gables | 1140 AM | Fort Myers | 90.1 FM |
| Fort Pierce | 88.9 FM | Ft. Walton Beach | 99.5 FM |
| Gainesville | 103.7 FM | Gainesville | 850 AM |
| Jacksonville | 102.9 FM | Jacksonville | 107.3 FM |
| Key West | 92.7 FM | Lake City | 94.3 FM |
| Live Oak | 98.1 FM | Live Oak | 1250 AM |
| Maitland | 540 AM | Marathon | 1300 AM |
| Miami | 88.9 FM | Miami | 790 AM |
| Mirimar | 94.9 FM | Mirimar | 610 AM |
| Ocala | 93.7 FM | Orlando | 92.3 FM |
| Palm City | 89.9 FM | Panama City | 92.5 FM |
| Panama City | 94.5 FM | Panama City | 98.5 FM |
| Pensacola | 88.1 FM | Pensacola | 100.7 FM |
| Pensacola | 107.3 FM | Pensacola | 1370 AM |
| Port Charlotte | 92.2 FM | Tallahassee | 88.9 FM |
| Tallahassee | 94.9 FM | Tampa | 94.9 FM |
| Tampa | 100.7 FM | Tavernier | 103.1 FM |
| Tampa | 102.5 FM | | |

3.4 SHELTERING IN PLACE

Sheltering in place means staying home, or at your current location, at the time of a disaster.

Should I stay or should I go?

Depending on circumstances and nature of the emergency, the first important decision is whether to stay or go. Understand and plan for both possibilities. Use common sense and available information to determine if there is immediate danger. In any emergency, local authorities may, or may not, immediately be able to provide information on what is happening and what you should do. Monitor the television or radio news reports for information or official instructions as they become available. If you're specifically told to evacuate or seek medical treatment, do so immediately. If you require additional travel time or need transportation assistance, make these arrangements in advance and see the Evacuation Planning section of this document (Section 3.3), for more information.

If it is necessary for you to shelter at home, local authorities, like the fire or police department, may warn you in a variety of ways. It will be important for you to be prepared and have the ability to take care of yourselves or others at home.

Reasons to Shelter at Home:

During an emergency or disaster, it may be safer for you to stay where you are or “shelter at home.”

A pandemic or global disease outbreak, where there is little or no immunity, could require people to self quarantine or shelter at home to stop the spread of disease.

During a pandemic or other public health emergency, hospitals and doctors will be overwhelmed with people needing immediate help. Medical facilities may not be open because of damage. Public transportation may not be available or operating. You may not be able to use roadways.

Dangerous chemicals may be polluting the air. If you see large amounts of debris in the air, or if local authorities say the air is badly contaminated, you may want to create a barrier between yourself and potentially contaminated air outside. This process is known as “sealing the room.” For more information see www.ready.gov/shelter.

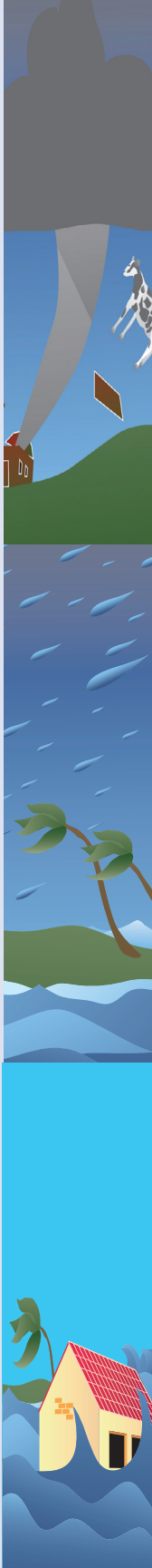

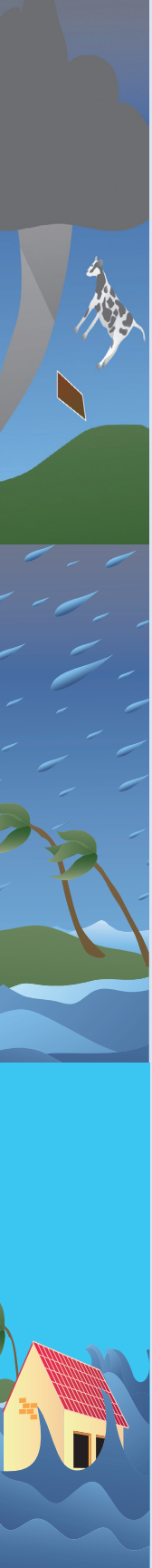

What about pets?

Make plans in advance for your pets and service animals. Keep in mind that what's best for you is typically what's best for your animals. If you must evacuate, take your pets with you, if possible. However, if you are going to a public shelter, it is important to understand that only service animals may be allowed inside. Plan in advance for shelter alternatives that will work for both you and your pets (loved ones or friends outside of your immediate area, pet-friendly shelters and veterinarians who would be willing to take in you and your pets in an emergency). For more information about pet preparedness, visit www.ready.gov/caring-animals.

How to prepare:

Florida Department of Health has developed a Neighborhood Emergency Preparedness Program (NEPP) to assist community members in organizing and educating neighborhoods to increase their level of preparedness to handle all types of health-related emergency incidents. It is designed to engage and mobilize small neighborhood teams to help foster self-sufficiency at the residential level. As part of NEPP, a training course was developed specifically to prepare Florida residents for sheltering in place. The "Home Care Series" training provides information on preparation and planning, prevention, general care, managing symptoms, and staying informed. It provides information for the general public, as well as specific considerations for older adults and for children. A free satellite broadcast and training manual with resources from the course is available at www.doh.state.fl.us/demo/BPR/NEPP/nepp.html.

Basic preparations should include:

1. Developing a disaster plan;
2. Putting together a disaster supply kit (See Appendix D for checklist);
3. Purchasing or making a first aid kit (See Appendix D for checklist);
4. Preparing medical history and medical related necessities;
5. Exercise the plan by performing drills and revising the plan based on identified shortfalls.

Preparing medical history and medical related necessities

Identify and locate important medical history documentation, including emergency numbers.

Always have a written record of the medical history for you and your family. If an influenza pandemic occurs, vaccination clinics could be set up. If this happens, you would need to bring your medical history with you. This record should include any special illnesses, allergies, or care needs and immunization records for children. Update it as necessary and consider sharing this record with other family members. The history should include any special equipment or medical supplies you use. In addition to “Disaster” and “First Aid” kit supplies, be sure to include:

- A copy of your medical insurance card and those of others;
- At least a week’s supply of your prescription medicine and for others in your household;
- A list of medications, including dosage and how often they are taken;
- Asthma medications or inhalers;
- Bites, stings, and allergy treatments;
- Cough and cold treatments;
- Fever and pain relief medicines;
- Heart and blood pressure medicine;
- Insulin and insulin supplies;
- Nonprescription drugs for pain relief, upset stomach;
- Preventative items like sunscreen and insect repellent;
- Safety pins;
- Vitamins and supplements;
- Wound care items.
- **Caution:** Syrup of Ipecac is no longer routinely recommended. If it is in your medicine kit, do **NOT** use it without medical advice as inducing vomiting may cause more harm than good.

Remember to include special supplies and equipment needed, or other special considerations for self, older adults, or children in the home such as:

- Activities and games to help keep children occupied;
- Denture needs;
- Diabetic testing supplies;

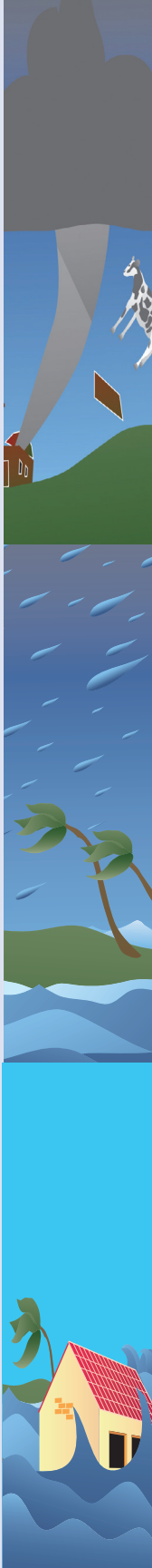

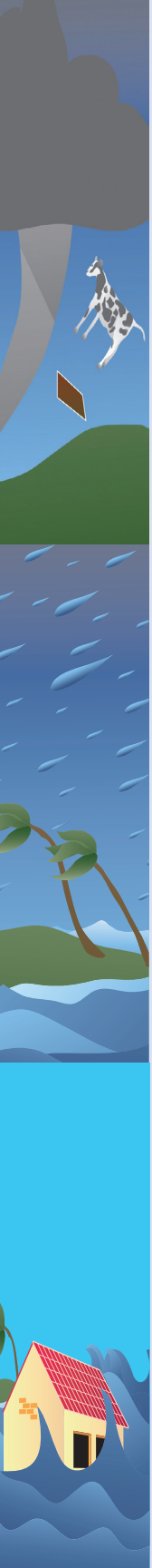

- Dialysis related;
- Extra batteries for hearing aids or other equipment like wheelchairs;
- Extra glasses or contact lenses;
- Medical power of attorney;
- Oxygen supplies including extra oxygen and back up or battery power;
- Sanitation supplies, such as child or adult diapers or a bed pan;
- Temporary alternate power sources (contact your utility company to get placed on their list for priority reconnection).

This list does not include everything, but provides an idea of symptoms that may be able to be managed at home. See references and resources below to get information on managing symptoms such as:

| | | |
|--------------------------|----------------------|---------------------|
| Acid reflux | Dementia | High blood pressure |
| Asthma | Depression | Injuries |
| Caregiver tips | Diarrhea | Mobility problems |
| Changes in mental status | Diabetes | Nausea, |
| Choking | Fall prevention | Poisonings |
| Constipation | Fever/burns | Upset Stomach |
| COPD | GERD | Vomiting |
| Dehydration | Heat-Related Illness | Other |

Important phone numbers:

- 211 - community information and referral services;
- 511 - automated traffic and transportation information line;
- 711 - for communicating with persons with hearing or speech impairments;
- Department of Elder Affairs Help Line- 1-800-96-ELDER (963-5337);
- Poison control phone number.
- **Note:** During times of emergencies, such as hurricanes or pandemic outbreaks, the Florida Emergency Information Hotline is activated to provide information tailored to the situation.

Local Resources:

- Aging Resource Center;
- American Red Cross Chapter;
- Area Agencies on Aging;
- Children’s Medical Services;
- Community Centers;
- County Health Departments;
- Emergency Management Office;
- Faith-based Organizations;
- Humane Society;
- Neighborhood Associations;
- Senior Centers.

General Safety Precautions to avoid injury:

- Continue to monitor your battery-powered radio or television for emergency information;
- Be careful when entering any structure that has been damaged;
- Wear sturdy shoes or boots, long sleeves, and gloves when handling or walking on or near debris;
- Be aware of hazards from exposed nails and broken glass;
- Do not touch downed power lines or objects in contact with downed lines. Report any electrical hazards to the police and the utility company;
- Use battery-powered lanterns, if possible, rather than candles to light homes without electrical power;
- If you use candles, make sure they are in safe holders away from curtains, paper, wood, or other flammable items. Never leave a candle burning when you are out of the room;

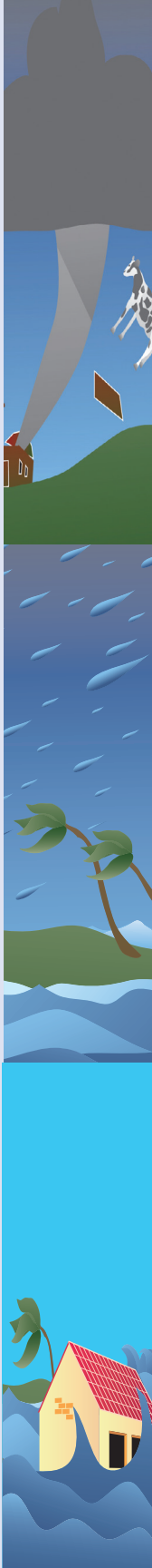

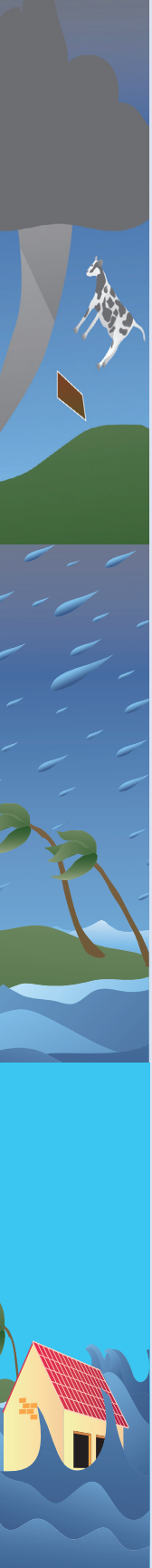

- Never use generators, pressure washers, grills, camp stoves, or other gasoline, propane, natural gas, or charcoal-burning devices inside your home, basement, garage, or camper—or even outside near an open window, door, or vent. Carbon monoxide (CO) – an odorless, colorless gas that can cause sudden illness and death if you breathe it – from these sources can build up in your home, garage, or camper and poison the people and animals inside. Seek prompt medical attention if you suspect CO poisoning and are feeling dizzy, light-headed, or nauseated;
- Hang up displaced telephone receivers that may have been knocked off by the tornado, but stay off the telephone, except to report an emergency;
- Cooperate fully with public safety officials;
- Respond to requests for volunteer assistance by police, fire fighters, emergency management, and relief organizations, but do not go into damaged areas unless assistance has been requested. Your presence could hamper relief efforts, and you could endanger yourself.

3.5 PREPARATION BEFORE A HURRICANE

The following precautions have been compiled using federal and state reviewed recommendation and should be taken well before a hurricane arrives.

Outside areas including the garage and shed:

- Check outdoor items that may blow away or be torn loose. Move items like potted plants inside and tie down any loose fixtures;
- Close shutters, awnings, windows and drapes. Deploy window protections (such as securing hurricane shutters, or boarding up of windows well in advance of the arrival of any winds. {See Part 4});
- Turn down canvas awnings or roll them up and secure them with sturdy rope or twine;
- Deploy window protections well in advance of the arrival of any winds. (See Part 4);
- Reinforce the garage door and tracks with center supports. Approximately 80% of wind damage starts with wind entry through the garage;
- Store chemicals, fertilizers, or other toxic materials in a safe section or secure area of the premises;

- Secure propane tanks. They should not be stored near sources of heat (like your water heater or other appliances).

Inside areas:

- Wedge sliding glass doors with a brace or broom handle to prevent them from being lifted from their tracks or being ripped loose by wind vibrations. Brace your garage door;
- Unplug all unnecessary appliances. Shut off gas valves;
- Turn refrigerators and freezers to their coldest setting. This preserves food as long as possible in case of a power outage;
- If you plan to stay home, check your supply of emergency food and water. (See Section 3.1) Avoid using electric appliances. Seek refuge in a small, interior area such as a hallway, closet or bathroom;
- If you are going to evacuate, shut off electricity and main switch, and gas and water at their main valves. Lock all windows and doors before leaving. Call relatives and friends and let them know what you are doing and where you are going. This will reduce the phone system overloading with them trying to get in touch with you;
- Package your valuables such as jewelry, titles, deeds, insurance papers, licenses, stocks, bonds, inventory, etc. for safekeeping in waterproof containers. Place valuables in a safety deposit box, if you do not have a safety deposit box, take these with you if you are going to evacuate. Keep important papers with you at all times;
- Check door locks to ensure doors will not blow away;
- Reduce potential water intrusion by ensuring proper caulking and/or weather-stripping on doors and windows.

Other:

- Fill the gas tank of your car. Make sure your battery is in good condition. Review county and state roadway maps;
- Check your battery-powered equipment. A radio could be your only link with the outside world during and after a hurricane;
- Refill prescription drugs. Obtain an extra supply of special medication.

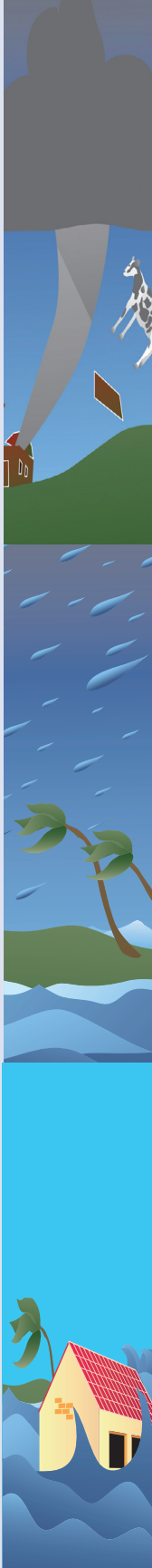

3.6 EVACUATION PROCEDURES FOR A HURRICANE

Your emergency supplies stock and evacuation kit should already be in place before there is a hurricane watch or hurricane warning. In your evacuation plan, you should already have decided if you will stay in your house, go to a shelter, or go elsewhere (friend's or relative's house). You should stay in a place that is away from any flood or inundation zones and that is able to withstand strong winds and rain. If you evacuate, you should already have made plans for your pet and prepared your house. If you have family, friends or a hotel to go to out of the area, it is preferable to living in an emergency shelter. If you plan to go to a shelter, you should already know the location of two or three shelters that are closest to your residence.

As a general guideline, you should evacuate if you are:

- Along low-lying coastal areas;
- Along low-lying areas subject to flooding (for example, near a stream or river);
- In any Federal Flood Insurance Zone such as a high velocity wave zone (V zone) or flood zone (A zone), even if your house is built for wave action and flooding;
- Along ridge lines exposed to strong winds;
- Living in certain wood frame structures (e.g., single wall without a continuous load path design) or lightly-constructed building.

Go to a hurricane shelter only if it is open. The decision to open a shelter depends on the severity of the event as well as local needs. In Florida, there are two types of shelters – general population shelters and special needs shelters.

If you go to a general shelter, you should bring some of your own supplies from your evaluation kit (i.e. bed linens, clothing, toiletries, personal medications, etc). Resources available at these shelters will vary. In these shelters, expect a safe, temporary refuge. They generally will have the basic necessities for survival that include food, water and a warm place to sleep, but will not have all the conveniences you may be used to in your home or hotel. Often, they tend to be crowded, noisy, and short-staffed with very little privacy. Listen to your local TV or radio station for shelters that are open to the public. A list of these general shelters in Florida by counties can also be found at www.floridadisaster.org/shelters/index.htm#general.

Florida also has designated “special needs shelters” that have supplementary power and capable of providing a safe environment for people who need assistance with a health condition or need special supervision by a health care professional. Although these provide more care than a general shelter, they do not provide the level of care found in a medical facility.

These facilities are for persons who require assistance due to physical impairment, mental impairment, cognitive impairment, or sensory disabilities during periods of evacuation or emergency situations. These individuals need to voluntarily register prior to an emergency, and meet certain eligibility requirements. Information on these shelters, how to become listed in the special needs registry, and other pertinent information can be found at: www.floridadisaster.org/disability/.

3.7 PREPAREDNESS AND SAFETY PROCEDURES FOR A TORNADO⁹

The following are some precautions that should be taken well before a tornado arrives:

- Know the difference between a Tornado Watch and Tornado Warning. (See Part 3.3.2 for definitions);
- Because many of Florida’s tornados occur after midnight when people are sleeping, it is important to have a NOAA Weather Radio;
- Keep fresh batteries and a battery-powered radio or TV on hand as electrical power is often interrupted during thunderstorms when information about weather warnings is needed most;
- If you are in a high-rise building and don’t have time to get to the lowest floor, find a place in a hallway near the center of the building;
- Take a few minutes with your family to develop a tornado emergency plan. Sketch a floor plan of where you live, or walk through each room and discuss where and how to seek shelter;
- Show a second way to exit from each room or area. If you need special equipment, such as a rope ladder, mark where it is located;
- If there is a siren/alarm warning system in your area, make sure everyone understands it;
- Mark where your first-aid kit and fire extinguishers are located;
- Mark where the utility switches or valves are located so they can be turned off-if time permits-in an emergency;

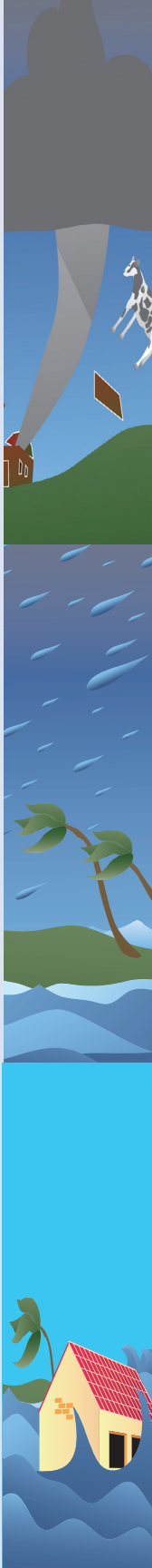



- Teach your family how to administer basic first aid, how to use a fire extinguisher, and how and when to turn off water, gas, and electricity in your home;
- Learn the emergency dismissal policy for your child’s school;
- Make sure your children know what tornado watches and warnings are, what county they live in, and how to take shelter, whether at home or at school;
- If you are outdoors, get inside a building or shelter if possible;
- If you are in a vehicle and there is no time to get indoors, get out of the car and lie in a ditch or low-lying area away from the vehicle using your arms to protect the head and neck (do NOT try to outrun a tornado).

Extra Measures for People with Special Needs:

- Write down your specific needs, limitations, capabilities, and medications. Keep this list near you always – perhaps in your purse or wallet;
- Find someone nearby (a spouse, roommate, friend, neighbor, relative, or co-worker) who will agree to assist you in case of an emergency. Give him or her a copy of your list. You may also want to provide a spare key to your home, or directions to find a key;
- Keep aware of weather conditions through whatever means are accessible to you. Some options are closed captioning or scrolled warnings on TV, radio bulletins, or call-in weather information lines.

Practicing Your Emergency Plan:

- Conduct drills and ask questions to make sure your family remembers information on tornado safety, particularly how to recognize hazardous weather conditions and how to take shelter.

Make a list of important information such as:

- Important telephone numbers, such as emergency (police and fire), paramedics, and medical centers;
- Names, addresses, and telephone numbers of your insurance agents, including policy types and numbers;
- Telephone numbers of the electric, gas, and water companies;
- Names and telephone numbers of neighbors;



- Name and telephone number of your landlord or property manager;
- Important medical information (for example, allergies, regular medications, and brief medical history);
- Year, model, license, and identification numbers of your vehicles (automobiles, boats, and RVs);
- Bank's or credit union's telephone number and your account numbers;
- Radio and television broadcast stations to tune to for emergency broadcast information.

Store the following documents in a fire- and water-proof safe:

- Birth certificates;
- Ownership certificates (autos, boats, etc.);
- Social security cards;
- Insurance policies;
- Will;
- Household inventory;
- List of contents of household; including serial numbers, if applicable;
- Photographs or videotape of contents of every room;
- Photographs of items of high values, such as jewelry, paintings, and collection items.

3.8 EVACUATION PROCEDURES FOR A FLOOD

The general rule if you are evacuating from a flood is to stay away from flood waters and head to higher ground. Stay away from moving water. Even six inches can make you fall or cause your car to stall. Two feet of moving water can move your car. If there is a flash flood and you are caught in your house, go to the second floor or the roof, if necessary.

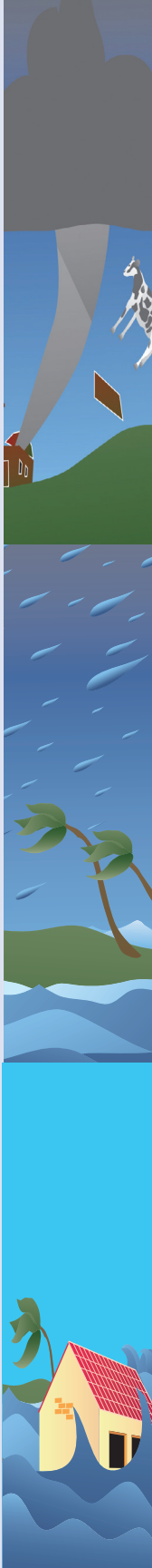

3.9 AFTER THE DISASTER

Injury may result from the direct impact of a tornado, or it may occur afterward when people walk among debris and enter damaged buildings. A study of injuries after a tornado in Marion, Illinois, showed that 50 percent of the tornado-related injuries were suffered during rescue attempts, cleanup, and other post-tornado activities. Nearly a third of the injuries resulted from stepping on nails. Other common causes of injury included falling objects and heavy, rolling objects. Because tornadoes often damage power lines, gas lines, or electrical systems, there is a risk of fire, electrocution, or an explosion. Protecting yourself and your family requires promptly treating any injuries suffered during the storm and using extreme care to avoid further hazards.

Gas:

- DO NOT USE matches, lighters, or appliances, or operate light switches until you are sure there are no gas leaks. Sparks from electrical switches could ignite gas and cause an explosion;
- If you smell the odor of gas or if you notice a large consumption of gas being registered on the gas meter, shut off the gas immediately. First, find the main shut-off valve located on a pipe next to the gas meter. Use an adjustable wrench to turn the valve to the “off” position.

Electricity:

- After a major disaster, shut off the electricity. Sparks from electrical switches could ignite leaking gas and cause an explosion.

Water:

- Water may be turned off at either of two locations:
 - At the main meter, that controls the water flow to the entire property;
 - At the water main leading into the home (If you need an emergency source of fresh water, it is better to shut off your water here, because it will conserve the water in your water heater);
- Attach a valve wrench to the water line (This tool can be purchased at most hardware stores);
- Label the water mains for quick identification;
- After tornadoes, excess moisture and water can contribute to growth of mold in homes and other buildings.

Injuries:

- Check for injuries. Do not attempt to move seriously injured people unless they are in immediate danger of further injury;
- Get medical assistance immediately;
- If someone has stopped breathing, begin CPR if you are trained to do so;
- Stop a bleeding injury by applying direct pressure to the wound;
 - Clean out all open wounds and cuts with soap and clean water;
 - Apply an antibiotic ointment;
 - If a wound gets red, swells, or drains, seek immediate medical attention;
 - Have any puncture wound evaluated by a physician;
 - Contact a doctor to find out whether more treatment is needed (such as tetanus shot);
- If you are trapped, try to attract attention to your location.

Safety During Clean-Up:

- Wear sturdy shoes or boots, long sleeves, and gloves;
- Learn proper safety procedures and operating instructions before operating any gas-powered or electric-powered saws or tools;
- Clean up spilled medicines, drugs, flammable liquids, and other potentially hazardous materials.

Children's Needs:

After a tornado, children may be afraid the storm will come back again and they will be injured or left alone. Children may even interpret disasters as punishment for real or imagined misdeeds. Explain that a tornado is a natural event. Children will be less likely to experience prolonged fear or anxiety if they know what to expect after a tornado. Here are some suggestions:

- Talk about your own experiences with severe storms, or read aloud a book about tornadoes;
- Encourage your child to express feelings of fear. Listen carefully and show understanding;

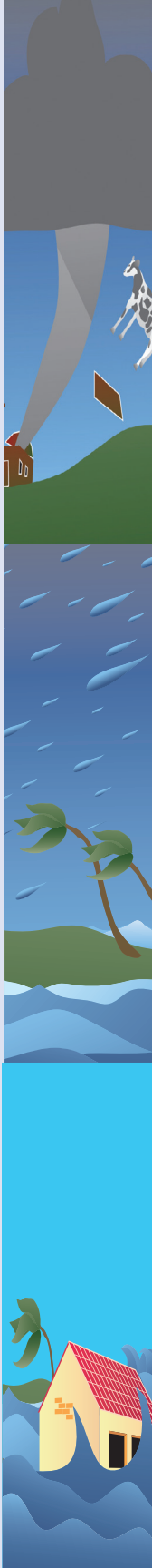

- 
- Offer reassurance. Tell your child that the situation is not permanent, and provide physical reassurance through time spent together and displays of affection;
 - Include your child in clean-up activities. It is comforting to children to watch the household begin to return to normal and to have a job to do.

NOTE: Symptoms of anxiety may not appear for weeks or even months after a tornado; they can affect people of any age. If anxiety disrupts daily activities for any member of your family, seek professional assistance through a school counselor, community religious organization, your physician, or a licensed professional. Counselors are listed under Mental Health Services in the yellow pages of your telephone directory.

3.10 EMERGENCY INFORMATION AND CONTACTS

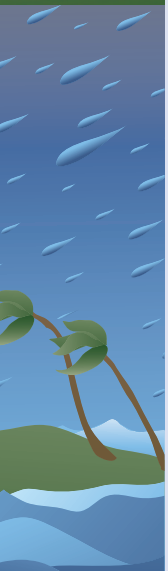

Each year prior to the Atlantic hurricane season, NOAA provides “Extreme Weather Information Sheets” (NEWIS) that are customized for Florida and each of the coastal states. For Florida, they break the state down into seven regions. These information sheets provide critical information for contacting government officials. These sheets are an ideal reference for the home, automobile or boat and can be downloaded from the NOAA website: www.ncddc.noaa.gov/NEWIS.

For general emergency information, please contact your state or local civil defense and emergency management agencies. The best time to contact them is when there is no emergency and you are planning and preparing. The worst time is when there is an emergency and the agencies are responding to hundreds or even thousands of calls. Nevertheless, call them if you absolutely need to. However, by planning and preparing ahead, you can help yourself and the agencies

One of the best sites for general emergency information can be found at the following website: www.floridadisaster.org.



NOAA Extreme Weather INFORMATION SHEET



To download the latest updated version of this sheet: www.ncddc.noaa.gov/NEWS

STATE INFORMATION

| | |
|-------------------------------------------------------------------------------------------------------------------------------------------------------|----------------------------------------------------------------------------------------------------------------------------------------|
| Florida Emergency Information Line (Only activated during disasters) | 1-800-342-3557 |
| Florida Division of Emergency Management (www.FloridaDisaster.org) | Non-Emergencies 850-413-9900 Emergencies Only 1-800-320-0519 or 850-413-9911 |
| Florida Evacuates.com | http://floridaevacuates.com |
| Florida Department of Transportation (www.dot.state.fl.us) | 1-866-374-FDOT (3368) |
| Florida Highway Patrol (www.flhsmv.gov/fhp) | 850-617-2000 (*FHP from any cell phone) |
| Florida Department of Health (www.doh.state.fl.us) | 850-245-4321 |
| Florida Office of Insurance Regulation (www.florir.com) | 850-413-3140 |
| Florida Office of Tourism (www.visitflorida.com) | 1-888-735-2872 |
| Florida Department of Law Enforcement (www.fdle.state.fl.us) | 850-410-7000 |
| Governor's Office (www.flgov.com) | 850-488-4441 or 850-488-7146 |
| Florida Attorney General (http://myfloridalegal.com) | 850-414-3300 |
| Florida Department of Environmental Protection (www.dep.state.fl.us) | 850-245-2118 |
| Florida Fish and Wildlife Conservation Commission (www.myfwc.com) | 850-488-4676 |
| Florida Department of Veterans Affairs (www.floridavets.org) | 727-319-7400 |
| Florida Department of Elder Affairs (http://elderaffairs.state.fl.us/index.php) | 1-800-96ELDER (963-5337) |
| Florida Department of Agriculture and Consumer Services (www.freshfromflorida.com) | 850-488-3022 |
| Florida Division of Animal Industry Emergency Links | www.doacs.state.fl.us/ai/adc/adc_emerg_manag_links.shtml |
| International Hurricane Research Center (www.ihc.fiu.edu) | 305-348-1607 |
| National Weather Service Forecast Office (Tallahassee, FL Office) (www.weather.gov/tallahassee) | 850-942-8851 |
| National Weather Service Forecast Office (Jacksonville, FL Office) (www.weather.gov/jacksonville) | 904-741-4370 |
| StormSmart Coasts | http://fl.stormsmart.org |
| US Coast Guard, 7th District (www.uscg.mil/D7) | 1-800-874-7561 |
| US Coast Guard, 8th District (www.uscg.mil/D8) | 504-589-6225 |
| Florida Power & Light Company (www.fpl.com) | Outage 1-800-4-OUTAGE (468-8243) |
| Progress Energy (www.progress-energy.com) | Outage 1-800-228-8485 |
| Talquin Electric Cooperative (www.talquinelectric.com) | Outage 1-866-899-4832 or 1-888-802-1832 |
| Tri-County Electric Cooperative (www.tcecc.com) | 850-973-2285 |
| Suwannee Valley Electric Cooperative (www.svec-coop.com) | Outage 386-364-5200 or 1-800-752-0025 |
| Florida Public Utilities (www.flpubc.com) | 1-800-427-7712 |

FOR EMERGENCIES CALL 911

FOR NON-EMERGENCIES CALL 211

COUNTY INFORMATION

Columbia

| | |
|----------------------|----------------------------------------------------------------------------------------------------------------------------------------------------------------|
| Emergency Management | 386-758-1125 |
| Sheriff | www.columbiacountyem.com 386-752-9212 www.columbiasheriff.com |

Dixie

| | |
|----------------------|--------------------------------------------------------------------------------------------------------------------------------------------------------------------|
| Emergency Management | 352-498-1240 |
| Sheriff | www.dixieemergency.com 352-498-1231 www.dixiecountysheriff.com/ |

Franklin

| | |
|----------------------|--------------------------------------------------------------------------------------------------------------------------------------------------------------------------------------|
| Emergency Management | 850-653-8977 |
| Sheriff | www.franklinemergencymanagement.com 850-670-8500 www.franklinsheriff.com |

Gadsden

| | |
|----------------------|-------------------------------------------------------------------------------------------------------------------------------------------------------------------------------------------------|
| Emergency Management | 850-875-8642 |
| Sheriff | www.gadsdensheriff.org/emergency_mgmt.html 850-627-9233 http://gadsdensheriff.org |

Hamilton

| | |
|----------------------|---------------------------------------------------------------------------------------------------------------------------------------------|
| Emergency Management | 386-792-6647 |
| Sheriff | www.hamcoem.com 386-792-1001 http://hamiltonsheriff.com |

Jefferson

| | |
|----------------------|------------------------------------------------------------------------------------------------------------------------------------------------------------------------------------------------------------------------------------|
| Emergency Management | 850-342-0211 |
| Sheriff | www.jeffersoncountyfl.gov/pl/county-departments/emergency-management 850-997-2523 www.jcsol.com |

Lafayette

| | |
|----------------------|----------------------------------------------------------------------------------------------------------------------------------------------------------------------------------------------------------------------------------------------------------------------|
| Emergency Management | 386-294-1950 |
| Sheriff | Information Line (Open only during emergencies) . . . 386-294-4441 www.lafayettecountyflorida.org/index.cfm?referer/content.contentList/ID/565/ 386-294-1222 |

Leon

| | |
|----------------------|------------------------------------------------------------------------------------------------------------------------------------------------------------------------------------------------|
| Emergency Management | 850-488-5921 |
| Sheriff | www.leoncountysoc.com/emergency-management 850-922-3300 www.leoncountysoc.com |

Liberty

| | |
|----------------------|--------------------------------------------------------------------------------------|
| Emergency Management | 850-643-2339 |
| Sheriff | www.libertycountyfl.com 850-643-2235 |

(Continued)

FLORIDA
North Central

Figure 3-1. NOAA Extreme Weather Information Sheet for North-Central Florida¹⁰

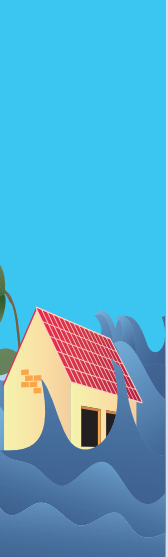
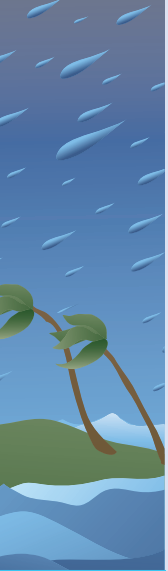

Part 4

Protecting Your Property

Protecting your property and protecting your family go hand in hand, since your house may be able to provide shelter from most weather conditions and perhaps even severe conditions. You don't have to be blown away when a natural hazard strikes. By strengthening your house, you can reduce the risk of damage to your home and possibly reduce insurance premiums. The two major Florida hazards considered in this part of the guide are hurricanes and wildfires. Additionally, you may be able to shelter in place during a minor hurricane related hazard event. For stronger hurricane events and for wildfires, the main focus is on trying to help ensure that you have a home to come back to after you evacuate in the face of the threat.

The amount of protection your house can provide from a natural hazard is limited by a number of factors which you should very carefully consider before taking shelter in your home:

1) The Severity of the Hazard Event. Protecting your home against a tropical storm or Category 1 hurricane is much easier than against a major event. For stronger storms, eliminating all damage is difficult, so the main goal is to significantly lessen the amount of damage which could occur. Fortunately, stronger storms occur less frequently and even when a stronger storm strikes, most of the area affected by the storm experiences weaker winds and storm effects than the strong winds and effects for which the storm becomes known. Each and every small improvement you invest in your home can make a difference. The more small improvements you make to your home, the less likely there will be severe damage to in minor events.

2) Your Location. Even though a hurricane may be a Category 1, you could experience much stronger wind. Being on a ridge, for example, amplifies the wind speed. Additionally, if your home is close to the open beach, a large bay, or a large marshland, the force of the wind will be much greater than if the house were surrounded in all directions by buildings, other homes and/or trees.

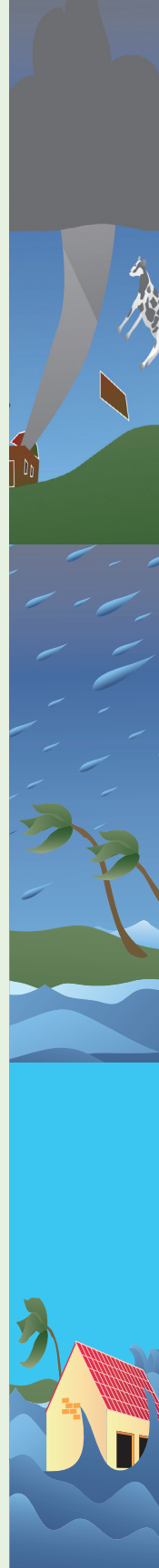



3) How Your House Was Built. The building codes adopted by many communities require new houses to have hurricane clips that tie the roof to the wall and other connectors that tie the wall to the foundation. This is known as “continuous load path connections.” Because of this requirement, many of the newer homes are generally much stronger than those built before this requirement was in effect.

4) How Your House Is Maintained. Maintenance of your house is important. Painting the exterior every five years and replacing any deteriorated wood protects your home and prevents weakening of the structure. Termites can also weaken a wood-framed house. If the wood in the house is rotten or has severe termite damage, it will be more difficult, or even impossible, to strengthen the home. So, it is important to maintain your house to ensure that you don’t have termites and by periodic painting and replacing materials. Proper maintenance will extend the life of a house in more ways than one.

5) How You Strengthen Your House. Even if your house was not built with hurricane clips, there are many small steps and some major ones that can be taken to retro-fit or address how to strengthen your existing home. The remainder of Part 4 concentrates on many of the options to consider when strengthening your home, whether you’re designing a new home or planning a retro-fit of an existing home, including:

- a. Sealing the roof deck and making sure that you have a high wind rated roof cover that is properly installed;current building code;
- b. Improving the connection of the roof-sheathing to roof-framing members (rafters or trusses);
- c. Minimizing the chances that water will enter through your attic ventilation system;
- d. Protection for windows, doors and garage doors;
- e. Reinforcing gable end roof overhangs, making sure there is structural sheathing on gable end walls and strengthening gable ends with bracing;
- f. Reinforcing weak roof framing members and connections of auxiliary structures (porches, carports, storage rooms);
- g. Roof-to-wall connections;
- h. Wall-to-foundation connections;
- i. Alternate sources of back-up electricity;
- j. Flood Retro-Fit measures (strengthening existing foundations and piers for flood forces, elevating mechanical equipment, elevating structures - particularly new ones - above the BFE).

You may be able to perform the work for many of these measures. However, if the work is beyond your capabilities consider hiring a structural engineer and/or architect to plan the strengthening/retro-fitting program for your home and a licensed contractor to do the installation/construction. Even if you do this work yourself, it is best to contact one or more of these professionals first to obtain guidance and details specific to your house.

The complete topic of retro-fitting existing homes has been tackled by numerous non-profit organizations and governmental agencies and the result of their hard work fills many reports and several excellent videos. The Institute for Business & Home Safety (IBHS) website has numerous articles, reports, and videos which are extremely informative and explain preventative measures which reduces losses from all natural hazards, including hurricanes: www.disastersafety.org.¹¹

The Mitigation Directorate of FEMA is continuously researching hurricane resistant designs and building methods for the construction of residences and the performance of residences which have been subjected hurricanes. All of the government publications are available for free and most can be downloaded conveniently from the FEMA website: www.FEMA.gov and from links at their Rebuild Smarter and Stronger page: www.fema.gov/safer-stronger-protected-homes-communities.¹²

The Florida Department of Emergency Management web site offers a hurricane retrofit guide with sections outlining many of the steps you can take to strengthen your home. The guide is available at: www.floridadisaster.org/hrg/index.asp.



4.1 CREATING THE WIND- AND RAIN-RESISTANT ENVELOPE

During a hurricane, it is very important to protect the envelope of your house from wind and rain. This protection starts with your roof because wind from a hurricane attacks any weaknesses in the roof. Once a weakness is exposed, adjacent areas can be more easily damaged and peeled away. Loss of roof cover can expose the roof deck and allow water to enter through joints between the roof sheathing. Loss of a piece of roof sheathing creates a hole where water can pour into your house. Attic ventilation system openings can also become pathways for water to be driven into your house so you should make sure that the elements/covers are well anchored and any vents on vertical wall surfaces are sealed before a hurricane strikes. Walls, windows and doors are also part of that envelope and can provide protection unless glass is shattered or doors fail. Protecting glass is often broken when wind gusts get up to 110 mph or higher. Taping your windows will not protect them from windborne debris. A broken window during a hurricane can be devastating in several ways: besides the incoming hurricane-force wind and torrential rain in your living area, there is shattered glass and debris from outside flying in. People sheltering in a room where glass has broken have been injured and killed. Even if no one is in the room, a critical problem created by broken windows and also by failure of doors is internal pressurization of your house that can lead to significant structural damage. (See Figure 4-1)

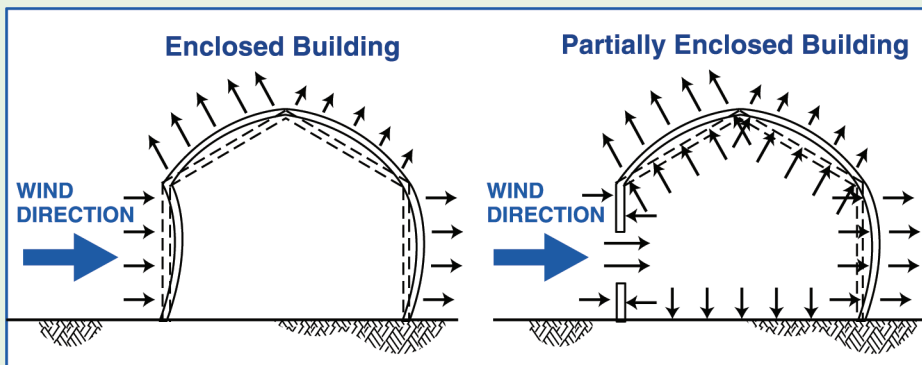

Figure 4-1: The diagram on the left shows a structure with the wind- and rain-resistant envelope intact. Pressure on the walls and roof comes from the outside only. In the diagram on the right, the structure's wind- and rain-resistant envelope has been breached due to a broken window. Now, pressure on the walls and roof comes from the outside and inside. The total amount of pressure on the roof and leeward wall increases significantly and can lead to the roof flying off and complete structural failure. (Source: FEMA's Coastal Construction Manual 2000).¹⁴

Some reports indicate that a door or window breach can potentially double the uplift forces on your roof and can significantly increase the chances that your roof will lift off.¹³ This is why FEMA indicated in their assessment report that breach of the building envelope and subsequent internal pressurization led to progressive structural failure for many houses.

4.1.1 Creating a Strong Hurricane Resistant Roof

The least expensive opportunity to substantially upgrade your roof is when you re-roof. Furthermore, in Florida, legislation and rules have been put in place that require some of the mitigation measures to be followed whenever a house is re-roofed. The basic process follows the following steps:

- a. Have the roofer remove all the roof cover and underlayment all the way down to the roof deck;
- b. Replace any damaged sheathing and repair any damaged roof framing members;
- c. Re-nail the roof deck so that nailing at least meets current code requirements (this is a requirement for any residential re-roofing in the State of Florida) - Most retrofit guidance recommends the use of ring-shank nails for re-nailing. Improved nailing of the roof deck is one of the mitigation measures that qualifies for hurricane insurance premium discounts in the State of Florida;
- d. Make sure that appropriate flashing is installed in all valleys and wherever the roof surface intersects with a wall or chimney and that drip edges are installed around the perimeter of the roof;
- e. Provide a secondary water barrier (again this is something mandated for any residential re-roofing in the State of Florida) - The initial intent of the legislation was to provide backup water intrusion protection with a system that would remain in place even if the roof cover is blown off. However, the terminology used in the legislation resulted in the use of felt paper being recognized as an acceptable alternative. Some secondary water barriers qualify for insurance premium discounts in the State of Florida. FEMA and IBHS both provide guidance on systems for providing secondary water barriers that are expected to stay in place even if the roof cover is blown off. IBHS now refers to the secondary water barrier as a “sealed roof deck.” Not all secondary water barriers are recognized by the insurance industry as qualifying for hurricane premium discounts. Generally, use of building code approved self adhesive modified bitumen tape over the seams between the sheathing or use of a code approved self-adhesive modified bitumen membrane over the entire roof deck qualify for insurance premium discounts. In addition, application of closed cell polyurethane based foam adhesives over joints between the sheathing from inside the attic is widely accepted for insurance premium discounts in the State of Florida.

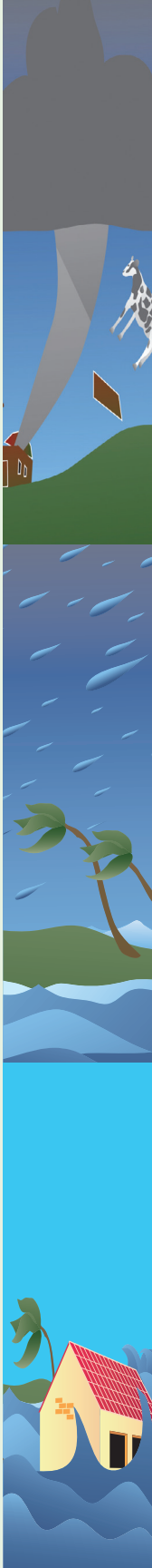



Caution: If a self-adhesive membrane is applied over the entire roof, manufacturers of the membranes require adequate or enhanced ventilation of the attic when these membranes are used. This is to prevent moisture condensation on the roof deck that can lead to damage and decay of the roof deck. Also the surfaces of some self-adhering membranes have been known to bond to the shingles and this can lead to roof sheathing damage the next time the home is re-roofed.

- f. Install an appropriate underlayment for the roof cover being installed. Make sure that the ratings meet or exceed the minimum requirements for the roof cover selected. If you are using felt paper in a high wind area, have your roofer use a 30 lb ASTM D226 Type II or ASTM D 4869 Type IV felt instead of a 15 lb variety and make sure that it is installed according to high wind guidance with 1-inch diameter round plastic or metal cap nails at no more than 6-inch spacing along all laps and 12-inch spacing in the field. If you use a synthetic underlayment make sure it has an ICC approval as an alternate to an ASTM D226 Type II or ASTM D4869 Type IV felt underlayment. The ASTM D4869 product approval includes a water spray test and there are reports that some new synthetic underlayments do not pass spray water tests- so be sure to pick one that sheds water. The self adhered modified bitumen membrane can qualify as the underlayment. However, if its surface treatment is sticky and shingles are to be used as the roof cover, it should be covered with a layer of felt to serve as a bond break and make it easier to re-roof in the future.
- g. Make sure that any ridge vents, off-ridge vents or other venting systems are rated for high winds, have passed the Florida Building Code's Testing Application Standard (TAS) 100 (A)¹⁵ and are securely attached to the roof.
- h. Install a roof cover that is rated for the design wind speed where your home is located.

Both FEMA and IBHS have additional resources and guidance to help you achieve a hurricane resistant roof cover regardless of the type of roof cover you choose.

4.1.2 Minimize Water Entry Through Your Attic Ventilation System

If you re-roof, there are opportunities to ensure that attic ventilation elements are properly installed and secured to your roof deck and roof structure. However, even if you don't re-roof, there are still steps that can be taken to reduce the chances that water will enter through a ridge vent, that off-ridge vents are securely installed, that shutters are prepared to seal gable end vents during the preparation for a storm and that soffit covers are securely attached. Soffits are the horizontal surface on the bottom side of the roof overhang at the eaves or along the gable roof overhang. Hurricanes in 2004 and 2005 showed that many elements of the attic ventilation system were vulnerable to damage in high winds and that failure of these covers or elements to keep water out led to significant water entry into homes and subsequent interior damage. Some things that can be done include:

- a. Make sure that any ridge vents are covered with products that have passed TAS 100 (A) testing and are approved for installation in Florida. The ridge vent is the last thing installed on a shingle roof so it is possible to easily improve its anchorage to the roof or to replace it with a new TAS 100 (A) approved product.
- b. Make sure that vinyl or aluminum soffit covers are well attached and if the soffit is longer than about 12-inches make sure it has a wood framing support member about midway between the wall and the edge of the roof overhang. You can push up on the soffit material to check for this structural support.
- c. If you have one or more gable end vents, you should prepare to have them shuttered with flat material that will prevent wind driven water from entering during the storm or if you also have ridge vents see if the gable end vent is still needed for attic ventilation and if not have sealed up.

4.2 PROTECTION FOR WINDOWS, DOORS, AND GARAGE DOORS

Protection of your home's envelope from breaches during a windstorm is critically important, particularly its vulnerable windows and doors which are commonly referred to "openings" since they fill open areas in the wall structure of the house.

Some reports indicate that a door or window breach can potentially double the uplift forces on your roof and can significantly increase the chances that your roof will lift off. This is why FEMA indicated in their assessment report, that breach of the building envelope and subsequent internal pressurization led to progressive structural failure for many houses.

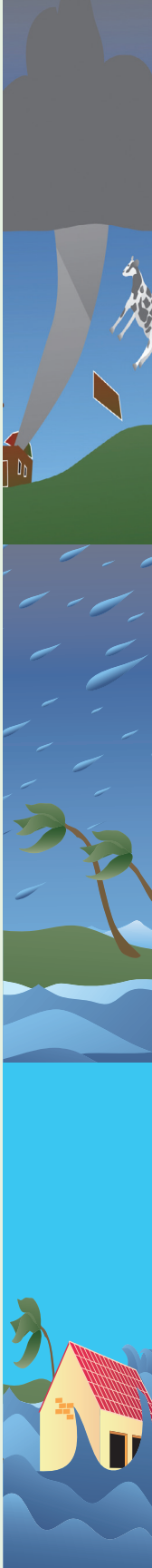



If your home is located in a windborne debris zone (any location where the basic wind speed for code purposes is 120 mph or greater), it is important that window coverings not only withstand hurricane force winds, but also withstand impacts. The usual standard for impact resistance is known as the “Large Missile Impact Test” as defined by several similar norms. Essentially, these tests determine whether a given shutter can withstand the impact of a nine-pound 2 x 4 fired at the shutter at 34 mph (50 ft/sec), followed by cyclic wind load testing.

Under the State of Florida ‘Hazard Mitigation Grant Program,’ correct installation of impact-resistant products to safeguard your home’s windows, may qualify for mitigation property insurance discounts. Your insurance company may require documentation indicating compliance with the Florida product approval system. Generally, discounts are available only if all glazed openings are protected with products that meet the large missile impact test standard. Visit the following websites for complete details: www.floridadisaster.org/Mitigation/Hazard/index.htm (and refer to tab: Residential Mitigation Techniques for the Florida Homeowner – ppt) and shutter selection matrix: www.floridadisaster.org/hrg/downloads/HRG_Shutter_Matrix.pdf.

There are a wide variety of types of commercial products available for providing opening protection. In some Florida counties a building permit is required to install opening protection systems. In these counties, home improvement stores will refer you to a licensed contractor or dealer. In other counties, you can purchase commercially produced approved products in home improvement stores and install them yourself. However, it is important to be aware that some installations are difficult for a homeowner and these include systems installed on houses with brick veneer and where masonry next to openings is hollow. For the best protection, coverings that are installed should be tested and approved to meet industry standards for hurricane impact. Check with the manufacturer. Always use licensed contractors and reputable dealers to ensure that you have a reliable installation where you won’t lose protection in the midst of the storm.

The International Hurricane Protection Association, a trade association group comprising manufacturers, contractors, and other industry professionals has several tips regarding selection of products, selection of installing contractors, and other useful information on its website: www.inthpa.com.¹⁶

Below, several types of opening protection systems are generically described. Within each category, numerous reputable manufacturers provide different products, each with individual features, benefits and cost. The prices shown are estimates for installed costs and represent local and nationwide averages as of May 2010. Pricing will vary between providers and will change over time. We encourage you to consult with a competent contractor specializing in supplying and installing these systems.

4.2.1 Roll-down Shutters

Roll-down shutters represent a window covering type that is easy to deploy and offers excellent overall protection features (Figures 4-2 and 4-3). These are permanently attached to the building. The shutter consists of a movable “curtain” of slats that is held in place by vertical tracks. When not deployed, the shutter stores in a hood that is housed above the window or door being protected. Most of the components of roll-down shutters are made from extruded aluminum.



Figure 4-2: Coastal home protected with roll-down shutters on all windows and doors. The shutter is held in place by vertical guide tracks and can be deployed manually or with integrated electric motor.
(Source: Roll-a-way/QMI)



Figure 4-3: Interior of home with deployed roll-down shutters. Roll-down shutters can be used not only for storm protection, but also for security, privacy, light, heat and noise control.
(Source: Roll-a-way/QMI)

Because the roll-down shutter makes solid contact with the window sill, patio deck or other structure at the bottom, this shutter type demonstrates a high level of protection against wind-driven rain in addition to wind and debris. Roll-down shutters can be deployed using a variety of operators - both manual and electric motor types (always make sure there is a manual override in case there is no power after a storm). These can be installed directly over windows and doors, or in some cases, at balcony’s edge to form an enclosure.

Since roll-down shutters are easily deployed, these often are used on a regular (non-storm) basis for light control, insulation against heat and noise, or for privacy and security.



The variety of features and methods of operation leads to a wide range of costs for this shutter type. As with all moving shutter systems, it is important to lubricate and activate them regularly so that you are sure they will work when you need them.

4.2.2 Accordion Shutters

One of the most commonly used shutter types in hurricane-prone regions is the accordion shutter (Figure 4-4). This is a permanently installed system with interconnected “blades” that operate between horizontal tracks. When not in use, the blades fold and are stored on either side of the door or window being protected. Accordion shutters can be manually deployed from the inside of the home, if the opening is a single- or double-hung window or an in-swinging window or door. Regular lubrication and movement is critical to ensuring that they stay functional. Installation prices range from approximately \$16 to \$30 per square foot.

Figure 4-4: Accordion shutter (shown in the open position) installed over a large window of a coastal home. Shutter has been installed to allow deployment from inside the home. (Source: Roll-a-way/QMI)



4.2.3 Decorative/Protective Shutters

For homeowners who wish to add a decorative flair to the home’s exterior while protecting windows against storm forces, Bahama (or Bermuda) and colonial-type shutters are available for window protection (Figures 4-5 and 4-6). These are most commonly made using extruded aluminum frames and louvers, although some composite materials have also found application in these types of shutters. Typically, these are finished using a durable exterior grade powder coating, or automotive-grade polyurethane paint system. While these shutter types imitate the design of traditional wood shutters, no wood shutter of either type has been tested and approved as opening protection. If there are gaps between the louvers, it is important to ensure that there is sufficient distance between the shutter and the window to prevent breaking the glass when the shutter is struck by flying debris in a storm. Once the window behind is broken, water can stream into your house unless the shutter is non-porous.

Bahama shutters consist of a one-piece louvered unit that is attached above the window and propped open to provide shade. As with any permanently installed shutter system, permission may be required from your homeowner’s association before you can proceed with installation. The cost of installation for Bahama shutters may range from \$30 to \$40 per square foot.

For many homes in Florida, *Colonial shutters* offer many advantages (quick deployment, aluminum panels) and are esthetically pleasing.



Figure 4-5: Bahama shutters made from durable extruded aluminum components add “Islands” flair to a home and provide effective opening protection. (Source: Roll-a-way/QMI)



Figure 4-6: Colonial shutters made from durable extruded aluminum components add a traditional look to the home and provide effective opening protection. (Source: Roll-a-way/QMI)

4.2.4 Storm Panels

Storm panels are made of aluminum, steel, or impact-resistant polycarbonate (Figure 4-7). The panels are corrugated and overlap for extra strength. Although the panels require storage when not in use, they usually stack together so the amount of space required is minimal. Storm panels are one of the most widely used and cost effective systems available to protect your windows during a hurricane. A wide variety of track options are available. While these systems are relatively inexpensive, they require much more effort for the homeowner to deploy than other types mentioned above. Costs may range from \$7 to \$15 per square foot of window area.



Figure 4-7: These 0.050 gauge aluminum storm panels offer cost effective storm protection. In this example, panels slip into a track above the window and secure onto a bottom track using wingnuts. (Source: Roll-a-way/QMI)



4.2.5 In-Place Systems

Requiring no advance deployment, impact-resistant systems that are permanently installed on a structure can be an attractive option for opening protection. Two types currently on the market are: 1) impact-resistant stainless steel screen units and 2) installed flat impact polycarbonate (Figure 4-8). Both of these have little, if any, negative aesthetic impact on the home. Impact-resistant stainless steel screen systems consist of a heavy gauge stainless steel screen mesh that is secured in an extruded aluminum frame. This unit is installed over the window to be protected. Because they are a porous protective system, they need to be installed with sufficient distance between the screen and the window to ensure that debris impacts will not result in window breakage or water and wind pressure entering the home. These are available as operable units, which facilitates cleaning and emergency exits. Screen units also provide excellent solar shading characteristics. These systems cost approximately \$25 to \$50 per square foot.



Figure 4-8: In-place stainless steel impact screen protects several windows of a coastal residence. This system requires no deployment and provides shade. (Source: Roll-a-way/QMI)

Flat impact polycarbonate units are available to protect most single and double window sizes and types found in residential homes. (Figure 4-9) These are made from UV-stable optical quality grades of polycarbonate and provide excellent protection against all storm forces. Because these systems are not operable from the inside of the home, emergency exit from the home must be considered before installing this system. Typical systems cost approximately \$25 to \$35 per square foot.



Figure 4-9: Flat impact polycarbonate panels are installed directly over windows of a coastal home. This window covering provides excellent storm protection with minimal aesthetic impact. (Source: Roll-a-way/QMI)

4.2.6 Fabric Windscreen

Impact-resistant fabric panels made from hightensile strength geosynthetic fibers such as polyethylene, or from reinforced PVC, have become increasingly popular for use as window and door protection (Figure 4-10). These systems are attached on two opposite sides of the window or door, usually to permanently installed panel mates or tracks with mounting studs. The panels include integrated grommets, which facilitate the deployment of the windscreens. These systems are also relatively inexpensive, costing approximately \$7 to \$12 per square foot. The polyethylene fabric types, which are basket weave systems, allow some light and visibility through the deployed screens. Some models incorporate emergency exit zippers. The PVC types are somewhat translucent, allowing light in the dwelling, but do not allow visibility through the screen.



Figure 4-10: Polyethylene basketweave fabric windscreen deploys directly over ground floor windows of coastal home. (Source: Roll-a-way/QMI)

In some cases, it may be difficult to protect your windows if they cover a large area or have an unusual configuration (for example, if they extend out past the wall.) Geosynthetic screens have been extensively employed to meet these needs and enclose large, even irregularly shaped openings.

Such systems range in price from \$20 to 40 per square foot. Due to installation requirements, of such systems, site-specific engineering is often required. Consultation with a contractor is recommended.

4.2.7 Impact-Resistant Glass Systems

Many hardware and home improvement stores offer the option of purchasing windows with impact-resistant glass as a replacement for existing windows. These windows come in a variety of styles, options, and costs, and are laminated to increase the impact strength of the glass.

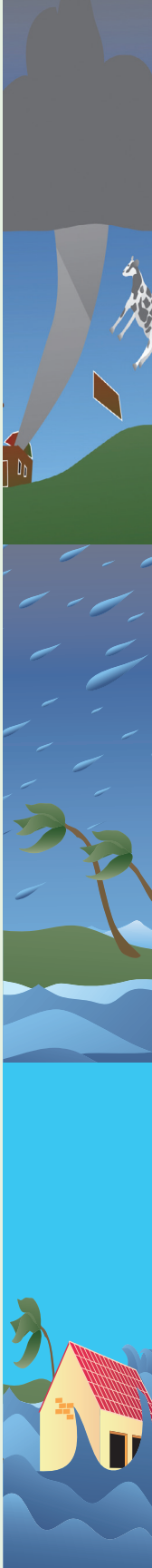



In order to withstand both wind forces and impact from windborne debris, window and door manufacturers have developed products with both sturdier frames and laminated glazing that is impact-resistant (Figure 4-11). Such systems are available in a variety of styles, options, and costs. While impact-resistant openings offer deployment-free protection, the glass can still be broken, but remains in the frame. These products are often available to the consumer through home improvement stores. Professional installation is highly recommended in order to insure that proper attachment of the windows to the structure is achieved.

Figure 4-11: This attractive window can be fitted with energy-efficient glass, impact-resistant glass, or both. The impact resistant glass consists of a laminate or film sandwiched between two glass panes. The frames are reinforced and the hinges have extra fasteners to withstand high wind events. During a wind event, debris may crack the glass, but the laminate will hold the window pane together in the frame and prevent breaching of the wind- and rain-resistant envelope. After the storm, the glass will need to be replaced.



4.2.8 Plastic Honeycomb Panels

A relatively recent and positive development in providing the consumer with more options for window protection is the introduction of plastic honeycomb panels made of polypropylene. These panels are installed like plywood and have many of the good properties of regular plywood, with fewer disadvantages. The panels are white and translucent.

The honeycomb panels also come in a clear plastic version that lets light through. This is an attractive option to other protective systems, which can significantly darken a house when they are in use. However, these panels are more expensive than the opaque version.

4.2.9 Window Film

An after-market product used to enhance glass breakage characteristics is commonly known as security window film. Such products are often called “hurricane film” or something similar. These claims cannot be substantiated by testing. Application of any of these window films to existing windows does NOT constitute adequate opening protection and should not be considered for use as opening protection. For more information, visit the website of the International Window Film Association (IWFA): www.iwfa.com.¹⁷

Table 4-1 lists the advantages and limitations of each type of window covering discussed above. A combination of different covering types is employed for most homes and is based on the needs and budget of the homeowner. An estimate of the installed cost for each type is given, assuming that the system will protect a 3-foot x 5-foot (3'x5') window. For further information regarding opening protection, visit the IBHS website, www.ibhs.org, in particular the Fortified for Existing Homes Program.¹⁸

4.2.10 Impact-Resistant Garage and Entry Doors

One of the most important, yet overlooked openings in a home that requires protection are its doors – both the garage door and entry doors. Most major suppliers of both types of doors offer products, with or without glazing options, that meet both wind and impact resistance requirements. Often, replacement of a non-rated door with one of these newer types is cost-effective, when compared to the cost of providing a covering for the door. Furthermore it is important to remember that a way out must be provided and if entry doors are protected by a shutter system, then leave from that door will likely be impaired. Consequently, replacing a couple of entry doors with rated products can provide the needed emergency exit. As with impact-resistant glazed windows and doors, any replacement of a door with an impact-resistant garage or entry door should be done by a qualified professional installer.

The garage door is a significant weakness during a hurricane due to its large area and the stress it is subject to (Figure 4-12). The wind can force it out of the roller track, especially if the track is light weight or some of the anchor bolts are not in place. This occurs because the door deflects too much under excessive wind pressure and fails. Garage door options include: (i) replacement with a stronger door, (ii) horizontal bracing, (iii) vertical bracing, or (iv) other types of a bracing kit. For many garage doors the vertical bracing is a popular and reasonably priced option. Bracing is done by using wood or light gauge metal girds bolted to the door mullions. You may also need heavier hinges and stronger end vertical supports for your door.

Double entry doors have been and continue to be a key vulnerability. Even doors with slide bolts at the top header and bottom threshold of the inactive door have been broken open in strong winds.



Figure 4-12: Because of their width, double-wide garage doors are more susceptible to wind damage than single doors.¹⁹
(Source: Florida Hurricane Depot)



Table 4-1: Pros and Cons of Various Types of Window Protection

| Type of Protection | Pros | Cons | Approx. Cost for 3'x5' Window Protection |
|------------------------------------|--------------------------------------------------------------------------------|--------------------------------------------------------------------------------------------------------------|------------------------------------------|
| Roll-down Shutters | Easiest to deploy, Best overall protection, especially wind-driven rain | Expensive | \$450 (manual) - \$900 (electric motor) |
| Accordion Shutters | Easily deployed, Simple manual operation, Good overall protection, Modest cost | Possible aesthetic issues | \$300 - \$450. |
| Bahama Shutters | Easily deployed, "Islands" decorative flair, Provides shade | Blocks some light and view | \$450 - \$675 |
| Colonial Shutters | Easily deployed, "Traditional" decorative flair | Cost, Requires adequate room for "swing" shutters | \$675 - \$900. |
| Storm Panels | Removable, Inexpensive | Manual deployment required, Must be stored when not in use | \$105 - \$225 |
| Stainless Steel Impact Screens | Always in place, Provides shade | Some aesthetic impact, Egress issues must be considered, Less effective for wind driven rain | \$375 - \$750 |
| Flat impact Polycarbonate Units | Always in place, Minimal aesthetic impact | Exit issues must be considered, Care must be taken in cleaning | \$375 - \$525 |
| Fabric Windscreen (Direct Mount) | Inexpensive, Easy to handle and store | Manual deployment required, Greater shutter deflection than metal systems | \$105 - \$180 |
| Impact Resistant Windows and Doors | Always in place, Many styles and options | Costs vary widely and can be high, Glass can still break requiring expensive replacement | \$450-\$900 and higher |
| Plywood | Inexpensive, Available | Manual deployment is difficult, Must be properly stored, Doesn't provide impact-resistance for winds >130mph | \$120+ |

Note: Window protection options we provided by Roll-away. Pricing is current as of May 2010

Generally, it is best to either shutter the double entry door or change to a rated product where one door is fixed and only one is operable. If it is shuttered, make sure that other doors provide the necessary emergency exit.

4.2.11 Plywood Shutters

Historically, plywood has been the most commonly used option for protection of window openings. This is undoubtedly due to its relatively low cost and ready availability. Plywood is available at almost every hardware store and provides protection at less cost than any of the other options discussed. However, plywood covers offer only a limited amount of protection in moderate level storms, and only if correctly labeled and properly installed. (Figures 4-13 and 4-14)



Figures 4-13 and 4-14: Not only is it necessary to install plywood opening covers correctly, it is also important to correctly label them and store them away from heat and humidity.

Disadvantages of plywood are that it can rot or warp if stored in a wet or warm area, and can be relatively heavy. You will need two people who can lift 30–40 pounds to help with the preparation and set-up of these shutters. Plan accordingly as it will not help if the people you are counting on to assist are not available during the deployment. Plywood shutters are good for easily accessible windows on the first floor, or windows that can be reached by terrace or patio, because they are heavy and can be difficult/dangerous if a ladder is needed for installation.

Plywood is increasingly viewed by both code and insurance entities as an inadequate means of protecting openings. While the International Residential Code (and other similar codes) allows some use of plywood under very specific conditions, these are restricted to areas where the design wind speed is 130 mph or less. Simply put, plywood does not demonstrate the levels of performance achieved by the engineered shutter types listed above.

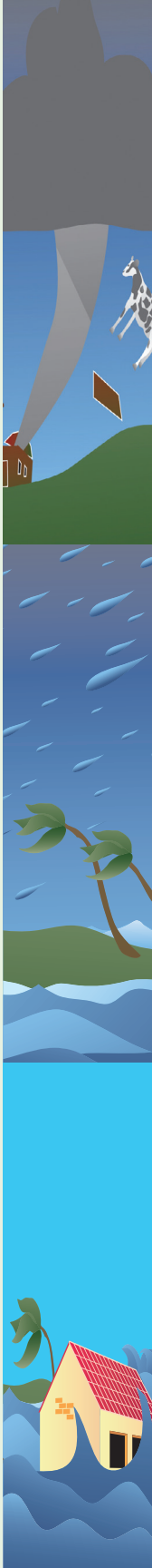



4.3 INSTALLING PLYWOOD SHUTTERS

Because financial cost is a barrier to some homeowners obtaining window protection, plywood shutters are a very attractive option. Yet these shutters take time to create and deploy. Some suggestions summarized here could reduce installation time and make this option even more attractive. There is more to installing plywood shutters than just buying plywood. Some of the tips provided in this section can also apply to the installation of plastic honeycomb panels.

4.3.1 Obtaining Assistance

Although you can install plywood shutters yourself to save on cost, you should still seek the advice of a licensed architect or structural engineer before you start. Professionals can guide you on specific details for your house's windows. The samples provided in this section may pertain to general applications, but remember that each window can be a little different. In addition, this section does not cover difficult applications such as installation for circular or triangular windows. Under the State of Florida's Residential Construction Mitigation Program, some insurance companies may offer discounts for window coverings.

4.3.2 Material to Use

For plywood shutters, the State of Florida's Residential Construction Mitigation Program recommends that you use at least 7/16 inch plywood. Buy thinner plywood only if you cannot handle the weight and your alternative is to do nothing. Thinner plywood is not as strong as 7/16-inch thick plywood and did not perform as well during destructive Hurricane Andrew in Florida in 1992. Seven-sixteenths inch or thicker is required under the and the State of Florida's Residential Construction Mitigation Program. Some insurance companies may allow use of thinner plywood to obtain a discount in hurricane insurance premiums.

You may want to consider thicker widths such as 3/4 inch, since it is stronger than 5/8 inch. In fact, some specifications for a safe room use 3/4 inch plywood. The major concern with the thicker plywood is the added weight and difficulty in handling. For most people, 5/8 inch exterior grade is a good compromise between strength and practicality during installation.

Your plywood should be treated to prevent termite damage when it is stored. In the past, harmful chemicals were used to treat plywood. Since the mid-1990s, plywood has been treated with borate, which is user friendly and requires no special handling precautions. Thus, there is no downside to handling the treated wood currently on the market.

There will be plenty of plywood in stock if you buy during hurricane off-season and the stores may even cut the wood for no or little extra charge. If you wait until a storm is approaching, there will be long lines, limited or no supply, and possibly no cutting service.

For your installation, you will need a hammer, duplex or double-headed nails, a circular saw, jigsaw, power drill with the proper bits, straight edge, tape measure, and the correct fasteners.

4.3.3 Measuring Your Windows and Cutting the Plywood

When you measure your windows, it is important to have sufficient overlap of 4 inches on each side of the window.

The overlap of the windows is essential because you will be putting the fasteners that attach the plywood: (i) away from the edge of the window; (ii) away from the edge of the plywood; and (iii) directly into the wall studs that surround the window rather than in the siding of the house.

Plywood comes in 4 ft. by 8 ft. sheets (48 inches by 96 inches). If you need a covering that is 54 inches by 54 inches, you will need to join together two sheets of plywood. The point where two panels meet is called a joint. These joints should be supported and can be connected by 2 by 4's.

It may take up to two days to measure the windows, buy the plywood, cut it to the proper dimensions, label the panels, and designate where all the fasteners are to be attached. This would be extremely difficult to do when there is an incoming storm. These preparations need to be done in advance.

4.3.4 Fasteners and Attaching the Panels

There are many different ways to attach plywood panels to the window frame. Some literature suggests using nails in an emergency. However, nails would not be as strong as screws and also are very difficult to remove after they are attached.

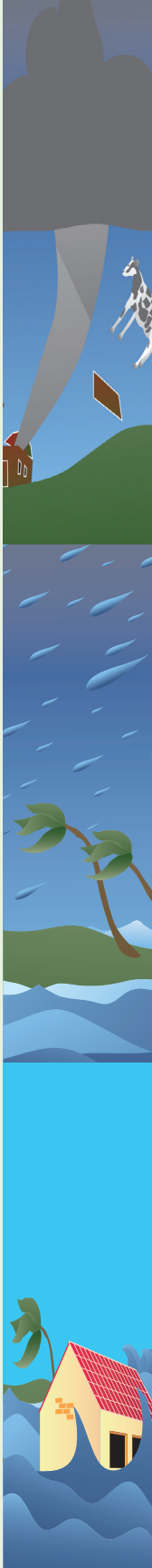



To install plywood shutters you will need bolts, wood or masonry anchors, large washers, and 5/8 -inch exterior-grade plywood. For windows 3 feet by 4 feet or smaller installed on a wood frame house, use 1/4 -inch lag bolts and plastic-coated permanent anchors. The lag bolts should penetrate the wall and frame surrounding the window at least 1 3/4 inches. For larger windows, use 3/8 -inch lag bolts that penetrate the wall and frame surrounding the window at least 2 1/2 inches. For windows 3 feet by 4 feet or smaller installed on a masonry house, use 1/4-inch expansion bolts and galvanized permanent expansion anchors. The expansion bolt should penetrate the wall at least 1 1/2 inches. For larger windows, use 3/8 -inch expansion bolts that penetrate the wall at least 1 1/2 inches. The tools you will need are a circular or hand saw, a drill with the appropriately sized bits, a hammer, and a wrench to fit the bolts. If the opening is larger than one sheet of plywood, you will need to make shutters with 2x4 bracing. This bracing can be two 2 '4s at the middle and bottom of the two sheets of plywood, evenly spaced, with the 2-inch side attached to the inside of the storm shutter. Attach the 2x4s to the outside of the storm shutter with 2-inch, 10-gauge wood screws before installing the shutter. For more information, visit www.floridadisaster.org/EMTOOLS/Severe/documents/agstwnd-fema.pdf.

4.3.5 Deployment

If the plywood is (i) precut, (ii) prelabeled, and (iii) premarked with the location of all fasteners, then deploying and installing them can be relatively quick. First, align the panel, and then hammer a duplex nail into each top corner of the panel to hold it onto the frame. With the panel held by the two duplex nails, your hands are now free to drill the self-driving screws into the appropriate premarked location for the remainder of the panel. The duplex nail can easily be removed later, as they are designed for easy insertion and removal.

It is very important that you test the deployment and fasteners well before a storm. This will allow you to catch and remedy any unforeseen difficulties. For example:

1. Do the screws drive in easily without pre-drilling? If not, consider pre-drilling, which is relatively quick. It is possible for one person to pre-drill with a bit and another to drive in the screws.
2. Do the screws strip? Obtain high quality wood screws and, if necessary, pre-drill. Buying good screws will reduce the time of installation.
3. Does your hand drill have enough torque, or does it run out of power easily? Consider an 18-volt drill instead of a 12- or 14- volt one. Have extra charged batteries and an extra charger. Also consider using corded power equipment.

Many of these questions can be answered by sales assistants at your hardware or home improvement store.

The State of Florida's Residential Construction Mitigation Program, recommends the following procedures for installing temporary emergency shutters:

- Measure each opening horizontally inside the exterior trim and vertically from the sill to the bottom of the top trim;
- If the window has an extended sill, measure from the sill to the top of the window trim;
- Add 8" to both the height and width to provide a 4" overlap for fastening purposes;
- Mark drill holes 2 inches from the edge of the plywood, at 12 inch intervals around the panel;
- Drill marked holes the same diameter as the bolts;
- Anchor the plywood panels around the opening and secure with bolts and fasteners in pre-drilled holes;
- Anchors must be permanently installed on the residential structure;
- If opening requires two panels, join panels with 2 x 4 bracing;
- Mark each plywood panel with the opening location, such as "front bedroom window, left side" to ensure speedy installation;
- Consider water-proofing the plywood panels or painting the panels to provide additional protection and longevity.

4.3.6 Other Methods of Installation

It is also possible to permanently attach the fasteners to the frame of the house. This has the advantage that the panels can be more quickly deployed and redeployed without drilling more holes. This method is useful in Florida because the panels need to be taken up and down frequently. Attaching the fasteners permanently takes more installation time, but most home improvement stores in Florida stock permanent anchors for use in mounting plywood and honeycomb shutters. These kits include wood or masonry type screws, wing nuts and plastic caps to protect people from being cut by the installed threaded rods that will stick out from the wall around windows. Either a licensed contractor or you can do the permanent installation. However, you may need some guidance from a licensed architect or engineer.

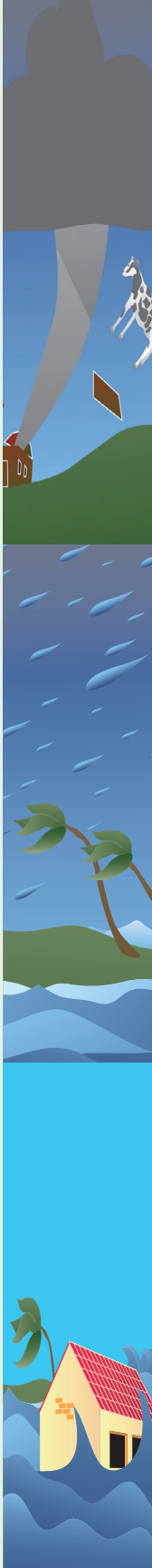



The methods discussed in this handbook are not the only ways to attach panels. The larger your window, the more plywood will flex under hurricane conditions. Thus, you should leave a 4-inch space between the plywood and the window. If there is not enough space, the window may crack, although the plywood would stay in place and continue to serve as a wind and rain resistant envelope. One way to get around this is to build 2 by 4 trim around the window frame and add stiffeners. This may take considerable time and very few window protection installers or homeowners do this.

If there is a hurricane strong enough to flex the plywood panel, then replacing your windows after a hurricane would be a relatively minor task if that is all the damage incurred. Note that during a hurricane, impact-resistant glass and laminated glass would be expected to break, even though the building envelope would stay intact if the glass attachment to the frame and the frame are strong enough. Thus these systems offer protection to the building envelope, although you must accept that the glass may need replacement after a hurricane. Finally, whenever sliding glass doors or other entry areas are protected, it is necessary to make sure that there are always two storm-protected doors that will be operable for access and exiting at any time.

4.3.7 Storing Plywood Panels

Storage space may be one concern you have about using deployable plywood or plastic honeycomb panels. It is possible to store the panels in your garage if they are organized neatly and stacked together.

As this handbook was being prepared, some companies were investigating the possibility of providing storage services for window coverings. The panels would be dropped off at your house before the beginning of hurricane season and picked up at the end of the season.

4.3.8 Timing Deployment with a Hurricane Watch or Warning

You should consider getting the panels ready even before a hurricane watch. There's a fine line between installing all the panels and fasteners too early only to have the hurricane veer away, and installing them too late when the wind makes it impossible to deploy. If there is a serious threat of a hurricane but no watch or warning yet, do any minor assembly such as joining two panels in advance. Then you can quickly mount the panels to the window if the threat increases.

If there is a hurricane watch, do the most difficult installations first. Begin deploying the panels, but not all the fasteners. For example, if you use a #8 screw on a 7 ft. panel, the fasteners should be 6 inches apart. Perhaps attach the four corners and the screws 18 inches apart. Leave one or two windows needed for access or light uncovered but ready to be protected. If the probability of a strike decreases and the hurricane turns away, there will be two-thirds fewer screws to remove and holes to patch with wood putty. If the probability of a strike increases, cover the remaining windows and add the remaining screws so that they are all spaced 6 inches apart. The goal would be that if a hurricane warning is announced, you could complete full installation to your house in 1–2 hours simply by installing one or two more window panels and all the remaining screws. It is important to note that all fasteners need to be installed for the shutter to provide the full level of protection during a hurricane.

This is a general guideline and will vary for each household depending on the situation. For example, you will need more time if you are protecting fifteen windows instead of five. Another consideration is how much help you will have and the number of other tasks you need to do to prepare your house and family. If you are deploying many windows, or have little help, consider deploying before a hurricane watch. It is better to have too much time than too little.

4.4 TREES

Considerable damage to your house can be done if tree limbs or branches fall onto or impact your house. Cutting or trimming trees that overhang your house are additional measures that you can take to protect your property during a hurricane. Even though trees provide a buffer to the full strength of the wind, there is a serious danger if there are large trees or limbs that are close enough to fall on the house. Few roofs are strong enough to withstand a falling 20-inch diameter, 40-foot tall pine tree.

Tree limbs or branches falling onto or impacting your house will cause considerable damage. Figure 4-15 illustrates the distance from the tree to the house to ensure that falling limbs do not affect the roof.

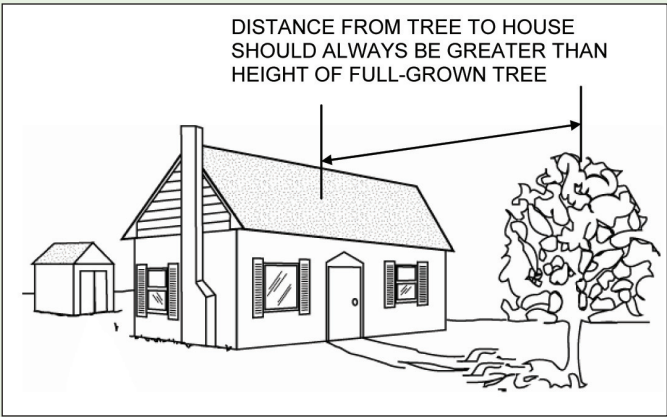

Figure 4-15: FEMA recommends that the distance between a tree and your house should always be greater than the height of the full-grown tree. This is to prevent trees from falling on the roof, either currently or in the future. (Source: FEMA)





If it is not possible to remove a tree, you can at least cut off all branches which hang over the roof of the house. If the branches and vines are so thick that the air cannot flow through, the tree will act like an umbrella and catch the wind before it topples over. Generally, you should hire a licensed tree trimmer to perform this work.

4.5 SAFE ROOMS

A safe room is a room designed to withstand winds from the strongest hurricanes (Categories 3–5) and strong tornados. Safe rooms should not be used in a flood zone, when there is threat of moving or rising water in that area. During a hurricane or other potentially high flood events, these areas need to be evacuated no matter how strong the room is against the wind and windborne debris.

It is much less expensive to build a safe room during original construction of the house. FEMA notes that while construction costs vary nationwide, the cost to build a safe room inside a new house (which can also double as a master closet, bathroom, or utility room) ranges from \$2,500 to \$6,000. The additional cost can be wrapped into the original home mortgage. This is a good investment that yields a sizable return in that it that adds value to your house as well as protection and peace of mind for your family. For more information regarding the design and construction of Safe Rooms see FEMA Publication 361, “Design and Construction Guidance for Community Safe Rooms” and FEMA Publication 320, “Taking Shelter From the Storm” available from www.FEMA.gov.

4.5.1 The Safe Room

State of Florida’s Hazard Mitigation Grant Program has a worksheet for Safe Room construction (http://www.floridadisaster.org/mitigation/Hazard/Documents/Tornado_Worksheet.pdf). Under contract with the Department of Community Affairs, Dr. Nur Yazdani, Ph.D., P.E., of the Florida A & M - Florida State University, College of Engineering, has developed this guide to help homeowners build a “retrofit room” in their existing houses. The “retrofit room” is designed to provide an area within the house that is resistant to wind speeds up to 140mph, which is the equivalent to either a Category 4 hurricane or an F2 tornado. However, this type of hardened area is not likely to qualify for financial assistance from federal funds. Federal funds are typically reserved for support of safe rooms that meet the national standards for safe room design.

If you are building or buying a new home, ask your architect, developer, home builder, or licensed contractor to provide a low cost estimate to build a safe room in a master closet or other suitable room. A guideline for cost could be the lower end of the estimate provided by FEMA of \$2,500 to \$6,000. The additional cost can then be wrapped into the original home mortgage. According to the state, when the new rules are developed, the safe room in a new house will be eligible for the grant.

4.6 IMPROVING STRUCTURAL RESISTANCE TO WIND DAMAGE

4.6.1 Strengthening Gable Ends

Failures of the gable ends of houses was common in Hurricane Andrew and have continued to be one of the more common types of structural failures observed in subsequent hurricanes. It is possible to significantly strengthen roofs of houses with gable ends. In most Florida jurisdictions this type of strengthening will require a building permit and the building officials will be looking for home specific engineering design of the bracing to be installed. Recent editions of the Florida Existing Building Code have included pre-engineered designs of gable end bracing that can be used without requiring an engineer to specifically develop designs for a specific house.

Hip-style roofs do not need as much bracing, as they are aerodynamically superior and they have the bracing built into the design of the structure. While gable end roofs have a flat end that is A-shaped, hip-style roofs have all four sides of the roof sloping towards the center of the roof.

An additional source of information regarding roof bracing can be found at the IBHS web site www.disastersafety.org.²⁰ There is a video on their site, called “Gable End Retrofit” which explains many of the details for reinforcing your roof and gives several construction tips.

4.6.2 Continuous Load Path Connections

The continuous load path connection is analogous to a chain: both are only as strong as their weakest link. Historically, the weakest link has often been the roof-to-wall connection. Thus, the hurricane clip was created. The concept of continuous load path connection is illustrated in Figure 4-16. This connection ties your roof to your house’s foundation and helps to keep the roof from blowing off during a hurricane.

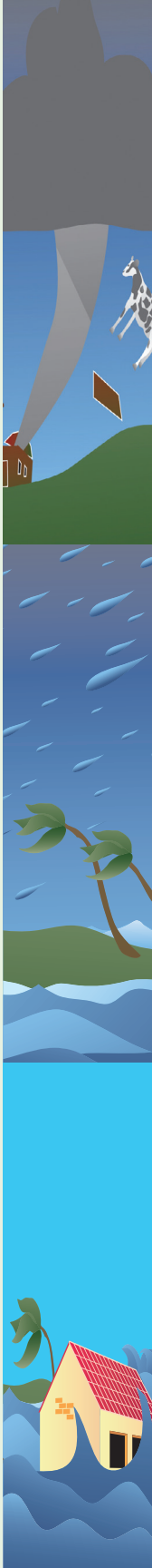

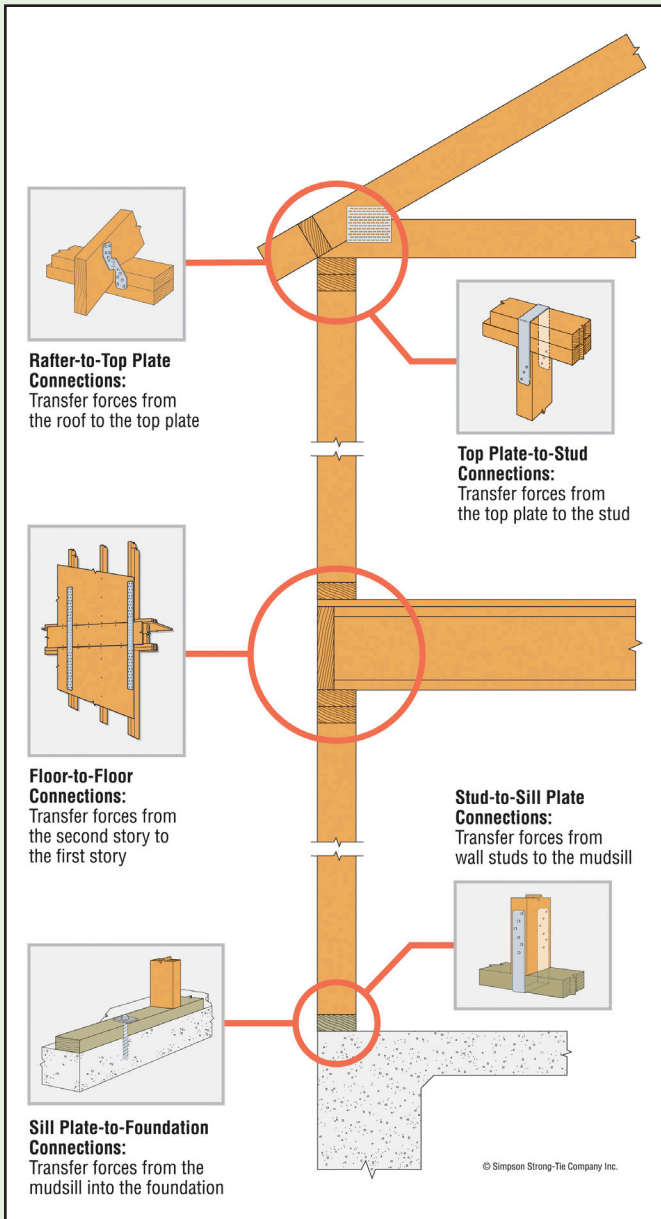

Figure 4-16: Continuous load path connection ties: (i) the roof to wall typically with hurricane clips and plate ties; (ii) the wall of a higher story to the wall of a lower story with straps; and (iii) the wall to the foundation with plate ties and anchors. For a single story house, the connections at are not needed. These connections are in all new houses (Table 4-1). Older homes usually will not have these features. In many cases, retrofit can easily be done for certain portions. (Source: Simpson Strong-Tie)

Naturally, all houses have some connection from the roof to the foundation, otherwise they would fall apart. However, in response to recent hurricane damage much stronger connections are now required in the form of straps, anchors and hurricane clips to protect against hurricane winds, as depicted in Figures 4-17 and 4-18.

For many homeowners, even minor damage of 15 percent or less can be an extreme hardship. In responses to wind and water event such as Hurricane Andrew in Florida in 1992, FEMA conducted an assessment of building performance and determined the following:

“Incomplete design and construction for load transfer and improper connections, especially between roof and walls, were found to be the most important factors causing structural failure of buildings due to uplift wind forces.”²¹

Recently built houses are required to have a complete load path connection. For older houses, it is possible to retrofit to add components of the connection. Each house is different but, in general, it will be easier and less expensive to put in hurricane clips than to do the foundation connection. Check with a licensed structural engineer or architect to determine what is feasible for your house.

It is preferable to do both the roof-to-wall connection and the wall-to-foundation connection. However, if the wall-to-foundation connection is too difficult or expensive because of the way your house was built, installing only the roof-to-wall connection is better than doing nothing. Remember, the weakest link for many homes is the roof-to-wall connection and thus the hurricane clip will make that weakest link significantly stronger.



Figure 4-17: This is the popular H2.5 hurricane clip installed during new construction of houses. Five nails are hammered into the lower beam (or top plate) and five more need to be used for the roof (truss-rafters) connection. A hurricane clip is required for each truss-rafters. Upon completion of this structure, the hurricane clip will be hidden from view. This particular clip costs 30 cents. For less than a dollar in material cost, stronger ones can be installed for both new and retrofit applications.

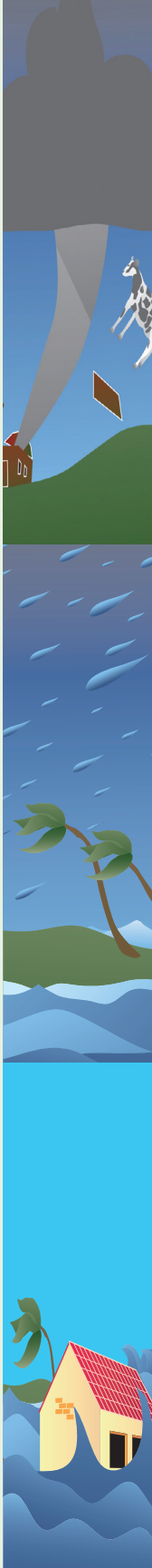

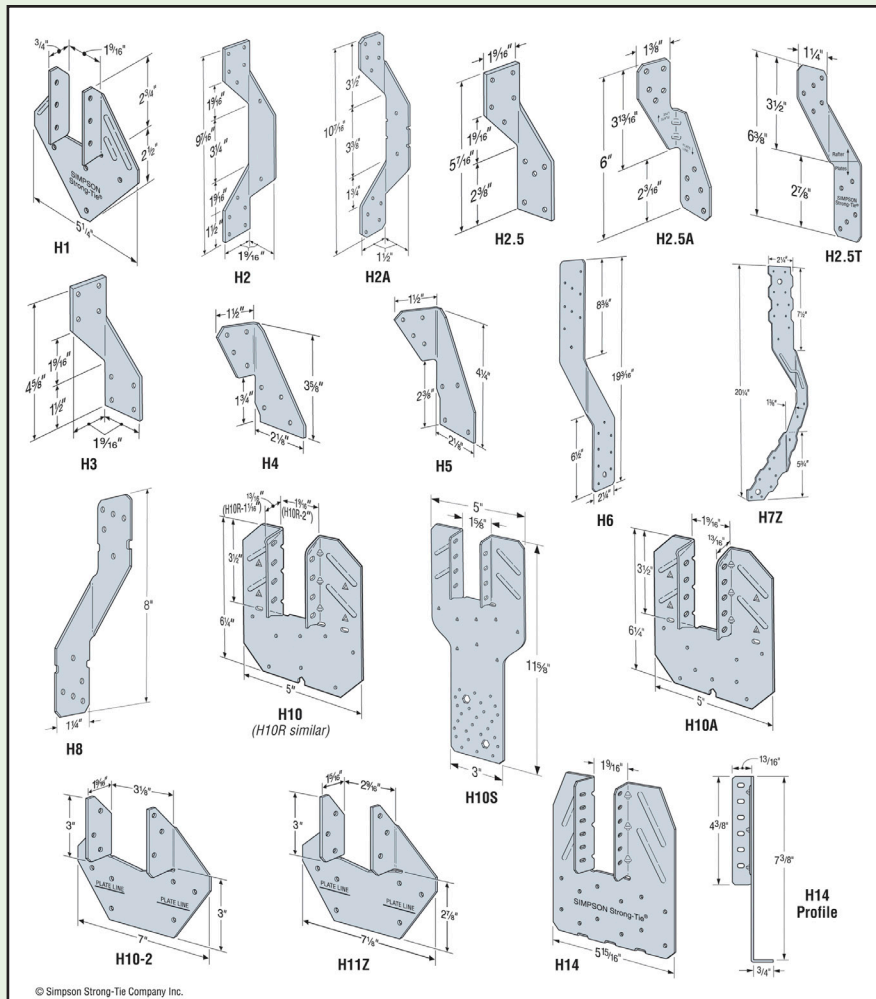

Figure 4-18: There are many different types of hurricane clips. Your licensed architect, structural engineer, or contractor can tell you what is suitable for your house and for the amount of protection you want. (Source: Simpson Strong-Tie)

4.7 RETROFITTING AN EXISTING HOME

When retro-fitting an existing home, you should consult with a licensed structural engineer or architect. The structural engineer can go over the cost and benefits of installing the following common retro-fit options:

1. Roof-to-wall and wall-to-foundation connections;
2. Hurricane clips only without additional foundation connection; or
3. Stronger connectors than those required in the current building code.

4.7.1 Roof-to-Wall Connection

Concepts regarding the roof-to-wall connection were covered in Part 4.6.2. A properly selected hurricane clip is required for each rafter. In addition, the rafters at gable end eaves should be strapped down. Exterior beams supported by corner columns also require strap down. For houses with post and beam roof construction, fasteners should be for roof rafter to roof beams, top of post to horizontal ridge beam and post to beam connections located at the exterior wall (see Figures 4-19, 4-20, and 4-21).

Figure 4-19: This is an example of retrofitting an existing house, originally built without hurricane clips. The popular H3 clip is used here; four nails attach the clip to the roof (truss-rafter) and four more nails attach to the wall or top plate below. For a retrofit, the clips are exposed on the outside of the house; therefore, both the clip and fasteners should be corrosion resistant and painted to blend with the exterior of the house. With the correct clip and nails you could perform the work or, if you prefer, hire a licensed contractor.

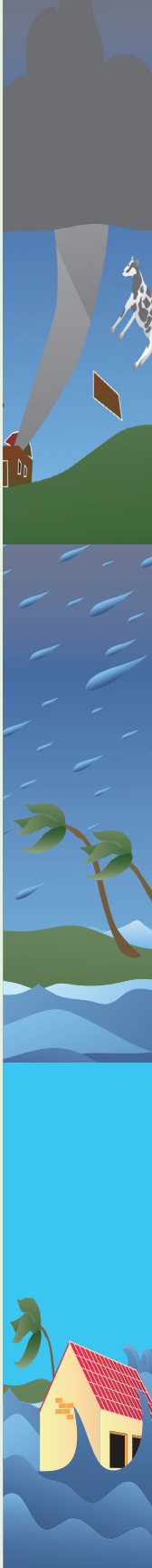

Figure 4-20: In this retrofit example, a hurricane clip attaches the roof structure to a horizontal ridge beam, which is in turn attached to the vertical post with a metal strap. This is an attempt to tie the load from the roof to the foundation, or create the complete load path connection. Note that these clips and straps are in the process of being painted. (Source: Hurricane Protection Services)

Figure 4-21: In some retrofit examples, it is possible to tie a portion of the house to the foundation. Here, a metal strap connects the vertical post to the foundation, which finishes the continuous load path connection from roof to the foundation. (Source: Hurricane Protection Services)



You should seek a licensed structural engineer or architect to select the proper connectors and nails for your house. You can then do either all or part of this work yourself, or hire a licensed contractor.





4.7.2 Foundation Uplift Strengthening Restraint

Strengthening the foundation to resist uplift will generally require the removal of interior finishes. The installation of uplift connections should be planned by a licensed structural engineer and only after they have inspected the home to understand materials and methods used to construct the home and have calculated the uplift requirements.

4.8 OTHER MEASURES TO PROTECT YOUR PROPERTY

Some additional measures you can take to protect your property during a hurricane include cutting or trimming trees that overhang your house and also bracing the trusses and rafters in your attic if your house has a gable end.

4.9 FLOOD RETROFIT

Protecting your property from flooding can involve a variety of actions, from inspecting and maintaining the building to installing protective devices. Most of these actions, especially those that affect the structure of your building or their utility systems, should be carried out by qualified maintenance staff or professional contractors licensed to work in your state, county, or city. The most important information to know about your home when considering flood prevention techniques is the base flood elevation (BFE) shown on the Flood Insurance Rate Map (FIRM) for your community.

The best source of information for protecting your property from flooding is found in the FEMA's Coastal Construction Manual: www.fema.gov/rebuild/mat/fema55.shtm. You should also familiarize yourself with the FEMA report "Protecting Your Property from Flooding," found at: www.fema.gov/plan/prevent/howto/index.shtm#4. This report covers:

1. Adding waterproof veneer to exterior walls;
2. Raising electrical system components;
3. Anchoring fuel tanks;
4. Raising or flood-proofing ventilation or air conditioning equipment;
5. Installing sewer back flow valves;
6. Dry flood proofing a building;
7. Building with flood resistant materials; and
8. Protecting wells from contamination by flooding.

In many cases flooding on a property can be caused by poor drainage. If this is the case, it may be of great benefit to address the drainage issue with the professional advice of a licensed civil engineer

4.9.1 Flood Prevention

One way to protect a structure and its contents from flood damage is to seal the building so that flood waters cannot enter. This method, referred to as “dry floodproofing,” encompasses a variety of measures:

- Applying a waterproof coating or membrane to the exterior walls of the building;
- Installing watertight shields over doors, windows and other openings;
- Anchoring the building as necessary so that it can resist floatation;
- Installing backflow valves in sanitary and storm sewer lines;
- Raising HVAC and electric system components above the flood level;
- Anchoring fuel tanks and other storage tanks to prevent flotation;
- Installing a sump pump and foundation drain system;
- Strengthening walls so that they can withstand the pressures of flood waters and the impacts of floodborne debris;
- Building with materials that can withstand flood waters for at least 72 hours (examples: concrete, ceramic tile, pressure-treated lumber, steel, metal, brick, epoxy paint, foam, and closed cell insulation);
- Ensuring wells are properly constructed to avoid contamination from flood waters.

Keep these points in mind when you dry floodproof:

Dry floodproofing is appropriate primarily for slab-on-grade buildings with concrete or solid masonry walls. Concrete and masonry are easier to seal, more resistant to flood damage and stronger than other conventional construction materials.

If you dry floodproof a “substantially damaged” or “substantially improved” building (as defined by the National Flood Insurance Program [NFIP] regulations) or a newly constructed building, and if the building’s lowest floor (including any basement) is below the BFE shown on the FIRM map for your community, your dry floodproofing must be certified as providing protection from the BFE. To obtain this certification, you must floodproof your building to a height at least 1 foot above the BFE. Check with your local floodplain manager or building official for more information.

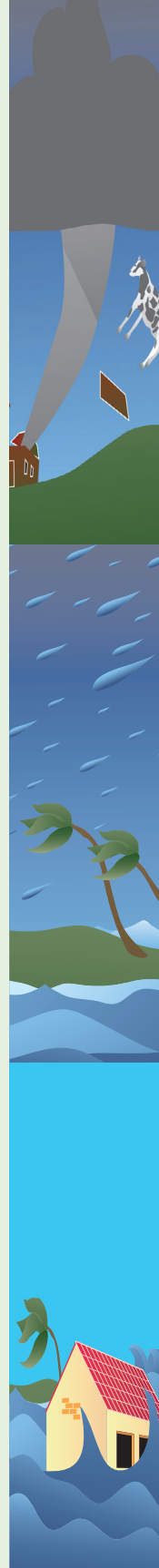



The height of your dry floodproofing should not exceed 3 feet. The pressures exerted by deeper water can cause walls to buckle or collapse. Before you use dry floodproofing to protect against greater flood depths, have a structural engineer evaluate the strength of your walls.

If your dry floodproofing measures require human intervention before flood waters arrive, such as placing shields over doors and windows, you should have an operations and maintenance plan that describes all the actions that must be taken and lists the persons who are responsible. It must also include a schedule of periodic maintenance that states how often the dry floodproofing measures will be inspected and who will perform the inspections.

The cost of individual dry floodproofing measures will vary with the size, condition and use of your building, the dry floodproofing height, and the extent to which you use contractors and engineers.

In many cases flooding on a property can be caused by poor drainage. If this is the case, it may be of great benefit to address the drainage issue with the professional advice of a licensed civil engineer.

An excellent source of information for protecting your property from flooding is found in the FEMA's Coastal Construction Manual available by search on FEMA's website: www.fema.gov or refer to the "Protecting Your Property from Flooding" found at: www.fema.gov/plan/prevent/howto/index.shtm#4.²²

4.10 PROTECTING YOUR HOME AND PROPERTY FROM FIRE

Wildland/Urban Interface (WUI) areas in Florida continue to increase. Changing weather patterns and the increased number of wildfires over the past several years have led to higher suppression costs. An increasing danger of loss of life and property has resulted from suppression of wildfires in the past (Figure 4-22). They may be called brush fires, grass fires, field fires, railroad fires, outdoor fires, backyard fires, or forest fires. No matter the name, the risk to residents and resources remains the same.



Figure 4-22: Florida wildfire (Source: Florida Forest Service)

Studies have shown that as many as 80% of the homes lost to wildfires could have been saved if their owners had only followed a few simple fire-safe practices. Successfully preparing for a wildfire requires the homeowner to take personal responsibility for protecting yourself, your family, and your property. The Firewise program highlights specific practices homeowners can use to assume personal responsibility in protecting their homes from the threat of wildfire. Figures 4-23 and 4-24 show a home before and after retrofit.

Preparing Your Property for Wildfires Using Firewise Concepts

Provide for adequate defensible space – at least 30 ft. in all directions around your home. This will create a sufficient buffer to slow or halt the spread of wildfire to your home. Nothing flammable should be planted or placed against the house. The Insurance Institute for Business & Home Safety recommends a “near-home” 0-5 ft. noncombustible zone.²³

1. Remove all dead vegetation from your yard, especially within the established 30 ft. zone around your home. Keep rooftops and gutters free of pine needle and other vegetative debris;
2. Remove any ladder fuels that are present such as shrubs and dead vines that will enable a fire to climb into the tops trees and spread the fire faster. Prune your tree limbs 6 to 10 ft. above the ground to avoid this ladder effect;
3. Trees and shrubs should be planted with adequate vertical and horizontal separation so that the fire cannot spread quickly. Creating plant islands is a good way to accomplish the desired separation;
4. Replace pine needles and bark mulch with gravel or rock mulch in beds close to the home. Avoid using rubber mulch products in these locations;²⁴
5. Locate firewood piles and propane tanks at least 30 ft. from the home. Do not store these items, or other combustible materials (e.g., lumber) under the deck;
6. Water plants regularly and keep grass mowed. Green plants are much less flammable than dead plants.

Firewise Construction Materials²⁵

1. The roof should be made of Class A fire-rated materials such as asphalt/fiberglass composition shingles, tile, slate, or steel;²⁶
2. Install double- or multi-paned windows. They provide more protection from radiant heat;

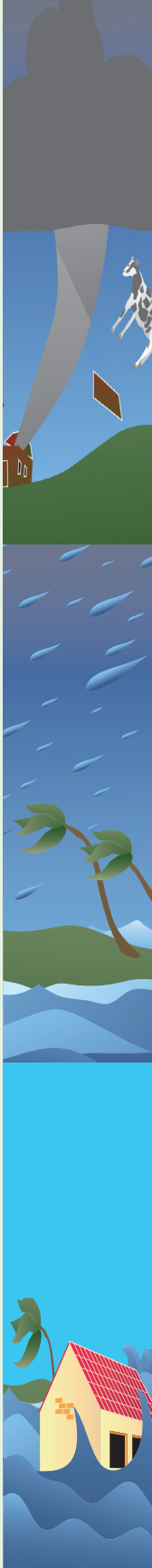



Figures 4-23 & 4-24: Residence before (above) and after (below) retrofit. (Source: Florida Forest Service)



3. Gutters should be cleaned regularly, covered with a noncombustible cap and vents should be screened with 1/8-inch noncombustible wire mesh to minimize the entry of flying embers out;
4. Build or remodel with noncombustible materials such as brick, fire cement, masonry or stucco. Make sure noncombustible materials are used for all exterior components from the foundation to the roof;
5. Use non-combustible materials when constructing attachments to the home like decks and fences.²⁷ A noncombustible (e.g., metal) gate next to the home is preferable;
6. Avoid storing combustibles under the deck (e.g., no firewood, lumbar, etc.);²⁸
7. The chimney should have a spark-arrester on it to minimize the number of escaping burning embers.

Firewise Landscaping

1. Plant with fire-resistant plants. These are plants that are least likely to burn because they have higher moisture content in the leaves, among other favorable characteristics;
2. Strategically form plant islands in areas away from home (i.e., beyond the near-home noncombustible zone);
3. Keep branches trimmed away from overhanging the home;
4. Develop a strict vegetation management plan for your property.

The goal of the Firewise program is to encourage community residents to accept the responsibility of living in the wildland/urban interface and for homes to be able to survive a wildfire even if the fire services cannot get there. For more information about Firewise log on to: www.firewise.org. Additional information can be found at www.disastersafety.org/wildfire.

Ready, Set, Go! Program (RSG)

RSG is a collaborative effort that can be effective in improving coordination and communication between emergency response agencies and the community. RSG is designed to complement other programs such as Firewise Communities/USA. The program builds on the Firewise concept that residents should accept personal responsibility for their decision to live in a WUI environment. RSG focuses on public education to help residents become a part of the wildland fire solution, by educating them about wildfire preparation, prevention, evacuation, and what to do if trapped. RSG strives to contain wildfire suppression costs and reduce injuries.

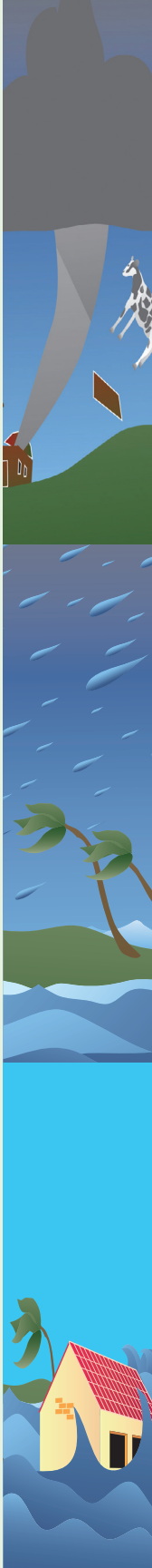



This program has been launched in Florida by the Florida Forest Service, Florida Fire Chiefs Association and its partnering Agencies; International Association of Fire Chiefs, Florida Fire Chiefs Association, USDA Forest Service, Florida Sheriffs Association, Department of Emergency Management, Insurance Institute for Business & Home Safety, American Red Cross, and Federal Alliance for Safe Homes.

Ready – be ready, be Firewise. Take personal responsibility and prepare long before the threat of a wildland fire so your home is ready in case of a fire. Create defensible space by clearing brush away from your home. Use fire-resistant landscaping and harden your home with fire-safe construction measures. Assemble emergency supplies and belongings in a safe place. Plan escape routes and make sure all those residing within the home know the plan of action.

Prepare your family

- Create a family disaster plan, including meeting locations, and rehearse it as a family;
- Get fire extinguishers and train your family how to use them;
- Show your family where the gas, and electric cut-offs are located;
- Plan for several evacuation routes, by car and on foot;
- Assemble an emergency supply kit;
- Appoint someone outside the area to make contact with family outside the area;
- Build a list of emergency contact numbers;
- Keep an emergency supply kit in your car;
- Purchase a scanner or portable radio to stay updated on the fire.

Set – Situational Awareness. Pack your emergency items. Stay aware of the latest news and information on the fire from local media, your local fire department and public safety

- Be ready to evacuate as soon as you are set;
- Tell family and neighbors;
- Dress appropriately, goggles and bandana;
- Have your emergency supply kit, batteries, and drinking water;
- Stay tuned to TV or radio updates.

Go – Act Early! Follow your personal wildland fire action plan. Doing so will not only support your safety, but will allow firefighters to best maneuver resources to combat the fire.

- Leave early enough to avoid being caught in fire, smoke, or road traffic;
- Don't forget about your pets;
- Meet at your designated emergency meeting location outside of the fire area.

4.11 HAZARD MITIGATION ASSISTANCE PROGRAM

FEMA's Hazard Mitigation Assistance (HMA) program is intended to encourage investment in long-term mitigation measures to reduce vulnerability to natural hazards. Under Section 322 of the Robert T. Stafford Disaster Relief and Emergency Assistance Act (Stafford Act) enacted under the Disaster Mitigation Act of 2000 (DMA2K), the State of Florida is required to have a Federal Emergency Management Agency (FEMA)-approved hazard mitigation plan in order to be eligible for federal hazard mitigation funding. The purpose of the State Hazard Mitigation Plan (SHMP) is to reduce death, injuries and property losses caused by natural or manmade hazards in Florida. The 2013 Plan identifies hazards based on the history of disasters within the state and lists goals, objectives, strategies, and actions for reducing future losses. Implementation of planned, pre-identified, and cost-effective mitigation measures not only helps reduce losses to lives, property and the environment but it streamlines the disaster recovery process. Hazard mitigation is most effective when based on an inclusive, comprehensive, long-term plan that is developed before a disaster occurs.

Among other things, the program can provide funds to states to assist homeowners in implementing mitigation measures to existing structures. Some of the project types that have been approved by FEMA for use to assist homeowners are:

- Property Acquisition and Structure Demolition - the acquisition of an existing at-risk structure and, typically, the underlying land, and conversion of the land to open space through the demolition of the structure. The property must be deed-restricted in perpetuity to open space uses to restore and/or conserve the natural floodplain functions.
- Property Acquisition and Structure Relocation - the physical relocation of an existing structure to an area outside of a hazard-prone area, or a regulatory erosion zone and, typically, the acquisition of the underlying land. Relocation must conform to all applicable state and local regulations. The property must be deed-restricted in perpetuity to open space uses to restore and/or conserve the natural floodplain functions.

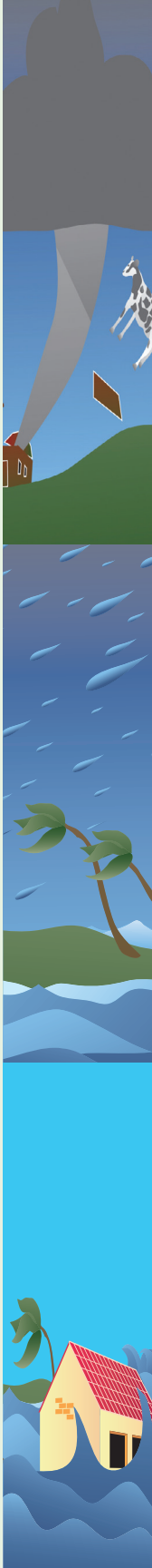



- Structure Elevation - physically raising an existing structure to an elevation at or above the Base Flood Elevation or higher if required by FEMA or local ordinance. Structure elevation may be achieved through a variety of methods, including elevation on continuous foundation walls, elevating on open foundations, such as piles, piers, posts, or columns, and elevating on fill. Foundations must be designed to properly address all loads, be appropriately connected to the floor structure above and utilities must be properly elevated as well. FEMA encourages applicants and sub-applicants to design all structure elevation projects in accordance with the American Society of Civil Engineers 24-05 Flood Resistant Design and Construction.
- Structural Retrofitting of Existing Buildings - modifications to the structural elements of a building to reduce or eliminate the risk of future damage and to protect inhabitants. The structural elements of a building that are essential to protect in order to prevent damage include foundations, load-bearing walls, beams, columns, structural floors and roofs, and the connections between these elements.

Funding under HMA programs is subject to the availability of appropriations and, for Hazard Mitigation Grant Program funds, to the amount of FEMA disaster recovery assistance under the Presidential major disaster declaration. To assist in establishing funding priorities, local and state mitigation plans are utilized to identify the highest risks.

4.12 LICENSED CONTRACTORS

Selecting a contractor to do your work is very important. This handbook does not recommend or endorse any particular company. It is up to you to select the companies and verify their record. Make sure the contractor is licensed, insured, and has not received complaints. You should always ask for a list of referrals. You can check the contractor's record at the Florida Department of Business and Professional Regulation (DBPR): www.myfloridalicense.com/wl11.asp.

The DBPR Online Services website provides information about applicants and licensed individuals for those professions and businesses that are regulated by the DBPR. If you would like to download general information (e.g. mailing addresses) about a particular group, please visit our free download site.

You can also look in your yellow pages using the key word "hurricane" for locating contractors who perform work in this area. When selecting a company, it is still necessary to do the proper due diligence and check their qualifications.

Hiring a licensed contractor is very important. The professions and businesses regulated by the DBPR and the disciplinary action that may be taken is administrative in nature, e.g., reprimand, fine, restriction of practice, remedial education, administrative cost, probation, license suspension, or license revocation. The Department cannot represent you in civil matters to recover fees paid or seek remedies for injuries. You may wish to consult a private attorney regarding these matters.

You should see a licensed architect or structural engineer, before you have extensive work performed. If you perform the work yourself, a licensed professional should be consulted for initial guidance, since every house is lightly different.

4.13 ELECTRIC AND POWER ISSUES

In case of an emergency, the power to your house should be turned off through the main breaker switch, circuit breaker panel, or fuse box. In addition, all homes should be equipped with ground fault circuit interrupters (GFCIs). GFCIs are inexpensive electrical devices that, if installed in household branch circuits, are designed to protect people from severe or fatal electric shocks. GFCIs could prevent over two-thirds of the electrocutions. Because a GFCI detects ground faults, it can also prevent some electrical fires and reduce the severity of others by interrupting the flow of electric current. GFCIs are commonly found in kitchens, bathrooms, laundry rooms, or other places where water and electricity are close together. If you don't have them, consider having them installed by a licensed electrician.²⁹

By following key safety precautions when dealing with electricity during and after storms and other disasters, you can help prevent death, injuries and property damage. Take care when stepping into a flooded area and be aware that submerged outlets or electrical cords may energize the water, posing a potential lethal trap.

Flooded Areas: Do not use electrical appliances that have been wet. Water can damage the motors in electrical appliances such as furnaces, freezers, refrigerators, washing machines, and dryers.

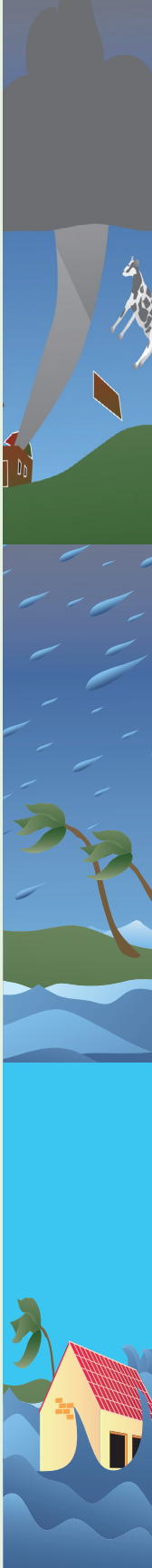



Wet Electrical Equipment: A qualified service repair dealer should recondition electrical equipment that has been wet. For more information, the National Electrical Manufacturers Association (NEMA) has produced a brochure, *Guidelines for Handling Water Damaged Electrical Equipment*,³⁰ for use by suppliers, installers, inspectors and users of electrical products to provide advice on the safe handling of electrical equipment that has been exposed to water. It outlines which items will require complete replacement or can be reconditioned by a trained professional. Equipment covered includes electrical distribution equipment, motor circuits, power equipment, transformers, wire, cable and flexible cords, wiring devices, GFCIs and surge protectors, lighting fixtures and ballasts, motors, electronic products including signaling, protection, communication systems, industrial controls, and cable trays. The NEMA brochure can be downloaded free of charge at www.nema.org/.

Downed Power Lines: These can carry an electric current strong enough to cause serious injury or possibly death (Figure 4-25). The following tips can keep you safe around downed lines:

- If you see a downed power line, move away from the line and anything touching it. The human body is a ready conductor of electricity;
- The proper way to move away from the line is to shuffle away with small steps, keeping your feet together and on the ground at all times. This will minimize the potential for a strong electric shock. Electricity wants to move from a high voltage zone to a low voltage zone.—and it could do that through your body;
- If you see someone who is in direct or indirect contact with the downed line, do not touch the person. You could become the next victim. Call 911 instead;
- Do not attempt to use another object such as a broom or stick to move a downed power line or anything in contact with the line. Even nonconductive materials like wood or cloth, if slightly wet, can conduct electricity and then electrocute you;
- Be careful not to put your feet near water where a downed power line is located;
- If you are in your car and it is in contact with the downed line, stay in your car. Tell others to stay away from your vehicle;



Figure 4-25: Downed or damaged power lines in a residential area can pose a serious danger to public safety. (Source: U.S. EPA)

- If you must leave your vehicle because it's on fire, jump out of the vehicle with both feet together and avoid contact with the live car and the ground at the same time. This way you avoid being the path of electricity from the car to the earth. Shuffle away from the car;
- Do not drive over downed lines.

4.13.1 Alternate Power Sources

Before discussing alternate power sources during an emergency, one general suggestion is to make your house as energy efficient as possible as you replace equipment and appliances in your house after they have outlived their normal life. For example, if the lights, a television, or refrigerator need replacing, consider products with the EPA's Energy Star label. These products may cost slightly more, but over their lifetime, the energy savings will far outweigh the small initial cost increase.

Energy efficient equipment will be especially useful during an emergency, when you may be on alternative forms of power with limited supply. For example, a regular 100-watt lamp running off an emergency power station (essentially built around a car battery) may run for two hours. That same emergency station can run a fuel efficient 23-watt compact fluorescent light almost 8–9 hours with the same light output. As another example, a refrigerator with the EPA's Energy Star label can run on a fuel-efficient generator for 16 hours on one gallon of gas (Figure 4-26). Since most refrigerators do not need to run continuously, it may be possible to run the efficient refrigerator on one gallon of gas for one or two days.

Figure 4-26: Items with the Environmental Protection Agency's Energy Star Label use much less energy than standard models. Items include washing machines, dishwashers, refrigerators, freezers, air conditioning units, and light bulbs.



4.13.2 Generators

Some households may require uninterrupted power because of the critical needs of some family members. For example, the elderly, disabled, or sick may require a respirator, dialysis machine, or other medical equipment. Some medicine such as insulin, which is stored over a month, may need to be refrigerated. For many families, the most important major power requirement is to run a refrigerator or freezer. If your family cannot get by without the refrigerator, or there are other critical power needs for medical or other purposes, then you may want to consider a portable generator (Figure 4-27).

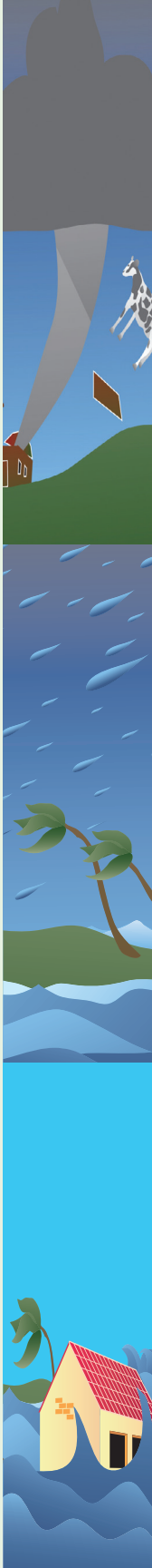

Take special care with portable electric generators, which can provide a good source of power, but if improperly installed or operated, can become deadly. Do not connect generators directly to household wiring. Power from generators can backfeed along power lines and electrocute anyone coming in contact with them, including line workers making repairs. A qualified, licensed electrician should install your generator to ensure that it meets local electrical codes.



Figure 4-27: Portable Generator

Other generator-related tips include:

- Make sure your generator is properly grounded;
- Keep the generator dry;
- Plug appliances directly into the generator;
- Make sure extension cords used with generators are rated for the load, and are free of cuts, worn insulation and have three-pronged plugs;
- Do not overload the generator;
- Use a ground fault circuit interrupter (GFCI) to help prevent electrocutions and electrical shock injuries. Portable GFCIs require no tools to install and are available at prices ranging from \$12 to \$30.

Most importantly, never run a generator indoors or in your garage because of the possibility of carbon monoxide gas accumulation, which cannot be detected by smell. Good ventilation is required. Operate your generator outside and away from open windows. Do not hook up a generator to your house power supply without a licensed electrician.

In general, when running your refrigerator with a generator, keep the refrigerator and freezer at the coldest setting. Refrigerators may only need to run a few hours a day to preserve food. Using a refrigerator thermometer, you should aim to maintain 40 degrees in the refrigerator compartment and zero degrees in the freezer. Open the refrigerator door as little as possible.

4.13.3 Power Stations

Power stations are found in many hardware stores and may have a radio, flash light, air compressor, battery jump starter, AC outlet, or DC outlet built around a modified car battery (Figure 4-28).

These units can come in handy during a power outage, since they can form part of your stock of emergency supplies and also provide limited emergency power. If your cordless phone does not work because the base of the unit has no power, a power station

could supply electricity so that calls could be made; an alternative is to use a corded phone. It should be noted that after an emergency, there may be many reasons the phone does not work that are beyond your control, such as heavy traffic or loss of function with the phone system.



Figure 4-28: Portable Power Station

4.13.4 Inverters

Inverters take the 12-volt DC power from your car battery and convert it to 115-volt AC power that can run household appliances. This can be very important if you need to run power tools in an emergency and the power is out. The inverter will drain your car battery, but look for inverters that have a low battery shutdown feature to prevent total battery drain. You should not run an inverter with the car running unless the manufacturer provides specific instructions with safety guidelines. In addition, the car should not be run in a garage, but rather in a well-ventilated area if the manufacturer approves of such procedures.

4.13.5 Battery Chargers

Your car battery can be an important source of DC and AC power with an inverter. To keep the car battery charged, you should consider a battery charger as part of your emergency supplies. The charger only works when there is household power or backup power through a generator, but it can recharge your car battery if it is needed. New units are small and portable and provide a quick charge to a dead battery in only a few minutes and a total charge in a few hours.



Part 5

Protecting Your Property with Insurance

There are two ways to protect your property from natural hazards with preventative action and insurance. The proactive way is to strengthen your house to address the individual hazard. If, however, there is still damage, insurance can provide resources to aid recovery.

Hurricane, wind and flood insurance are important for all residents, and are often a requirement for bank loans. Flood insurance is not only needed for those in flood zones and areas with periodic flooding, but can also be important even if you are outside an official flood zone because flood can occur in areas that have been mapped as flood zones. Development of surrounding areas can change your flood risk over time.

5.1 HURRICANE INSURANCE

You need hurricane insurance to protect your property from the winds of a hurricane. A regular homeowner's policy will not cover hurricanes. Coverage is typically provided in terms of replacement costs, or the cost to rebuild your house. Figures 5-1, 5-2, 5-3, and 5-4 illustrate the damage Hurricane Dennis did to many homes in Florida.

Florida law requires insurance companies to include coverage for windstorm damage caused by hurricanes. When you apply for coverage, the company must provide a price for windstorm coverage. This covers losses that can occur as a result of a hurricane and includes damage to the interior and exterior of a building. By law, this coverage also includes damage caused by dust, snow, sleet or rain.

The state legislature has provided several designations to the state with regard to wind damage. Much of the state falls within a high-risk "wind-borne debris region" which includes all of its coastal lands and barrier islands as well as some inland areas. This area may experience wind speeds of 120 to 150 mph, and special building codes apply to it. The remainder of the state contains areas that may experience maximum wind speeds of 100 to 110 mph.

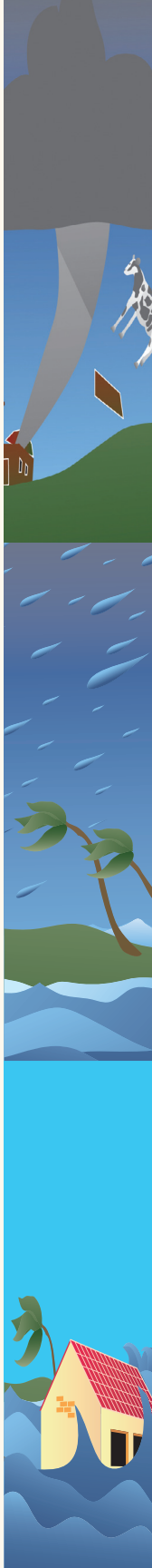



Figure 5-1: A collapsed home on Carabelle Beach
(Source: Rosalyn Kilcollins)

Figure 5-2: Structural damage to a concrete home
(Source: Rosalyn Kilcollins)



Figure 5-3: Structural damage
to a home located on US 98
(Source: Rosalyn Kilcollins)

Figure 5-4: Internal damages
to an Eastpoint home
(Source: Rosalyn Kilcollins)



Because of the state's long history with hurricanes causing considerable damage to property, many private insurers have been reluctant to offer hurricane insurance. As a result, in 2002 the state legislature created a non-profit government corporation, the Citizens Property Insurance Corporation (Citizens) to provide hurricane insurance coverage to individuals who can't get insurance from private companies, due to high risk factors. Premiums are generally higher than what private insurers charge for similar coverage. Citizens has more than 1 million policies that cover homeowners in the state of Florida. You can find more information from Citizens at their website: www.citizensfla.com/.

The following are some things you need to think about when considering hurricane insurance.

- Does the policy have an inflation guard that increases each year as the cost to rebuild goes up? Construction costs have steadily increased and may increase even more so after a natural disaster;
- After a hurricane, there can be widespread damage and very few contractors or supplies available to perform repairs. This can result in an increase in cost to rebuild. Some homeowners have chosen to increase their insurance coverage by 30–40 percent to account for an expected spike in future construction costs after a hurricane;
- Additions or improvements to your house made since your initial policy purchase may not be covered, so it is important to have a periodic appraisal so that your coverage is adequate;
- Understand your policy. Many policies cover only hurricanes and not lesser events such as a tropical storm or a tropical depression;
- Make sure you have coverage for: (i) your main structure, (ii) detached structures, (iii) the contents in your house, and (iv) expenses for loss of use (like hotel stays). Only coverage for the main structure is required by the banks, so you may not have sufficient coverage for the remaining items;
- Basic insurance policies frequently just pay to restore a home structure to its before event condition. When building codes and ordinances change, you may be required to rebuild differently. Consequently, make sure that your policy includes law and ordinance coverage that will pay up to an additional 25% to 30% of the cost of rebuilding to cover any additional costs associated with meeting the latest building code requirements. If it isn't automatically covered, it can usually be added for a relatively small additional premium.

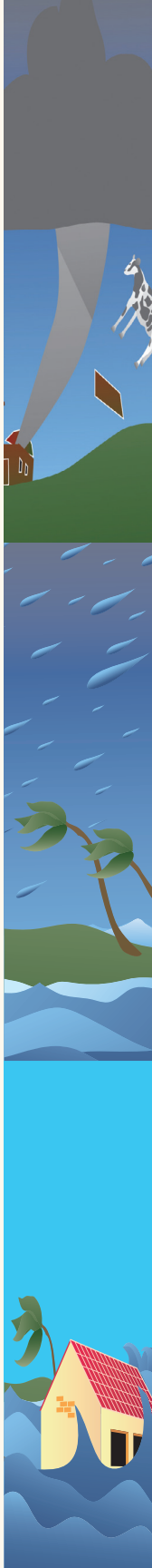

5.1.1 Insurance Discounts for Installation of Hurricane Protection

Florida statute 627.711 provides the opportunity for home-owners to have insurance premium discounts for hurricane loss mitigation. Your insurance policy is divided into two premiums, one for damage caused by hurricane force winds, and one for all other damages. Under the law, you are allowed to choose a \$500, 2%, 5%, or 10% deductible depending on the actual value of your home. The larger your deductible, the lower your hurricane wind premium will be. However, if you have a higher deductible, your out-of-pocket expenses will be higher.

Insurance companies are required by law to offer the homeowner discounts for improvements you make that reduce damage caused by hurricane winds. Improvements that help secure your roof so it does not blow off, and protecting your windows from flying debris are the two most cost effective measures that you can take to safeguard your home and reduce your premiums. Homeowners should contact a licensed contractor for an estimate, since these improvement costs vary. You can find a Certified Contractor in your area by visiting the Florida Department of Business and Professional Regulation at www.myfloridalicense.com.

The maximum premium discount will vary by your location and age of your home (dependent on what Florida Building code was in effect when your home was built). The maximum discount that homeowners can take is 88%. For up-to-date information, one of the best sources is the Florida Division of Emergency Management, Florida Disaster website at: www.floridadisaster.org/mitigation/.³¹

Consider work to strengthen your home as a home improvement that adds value and longevity to your house while protecting your family and offering peace of mind. With a home improvement or home equity loan to pay for the work, you may be able to get: (i) discounts on hurricane insurance premiums, (ii) grants from the state under the Loss Mitigation Grant Program, (iii) a lower interest rate because your house is used as collateral, and (iv) a tax deduction on the interest (check with your accountant or financial institution).

5.2 FLOOD INSURANCE

Standard homeowner's insurance policies do not cover floods which include hurricane related storm surge and rising water. Your normal wind and even hurricane insurance will not cover interior flood damage unless the damage is due to wind damage that leads to rainfall intrusion into your house. Because of these factors, you should consider specific flood insurance offered by the National Flood Insurance Program that can protect your home from floods associated with tropical storms, hurricanes, and heavy rains. Note that this insurance has limits and if the value of your home or belongings exceeds these limits you should consider getting additional flood insurance from the surplus market.

Relying on federal disaster assistance for flooding is not a good strategy. Federal disaster assistance is only available if a flood is declared a federal disaster; more than 90% of all disasters in the United States are not declared as such. Also, this federal disaster aid usually comes in the form of loans that must be repaid with interest.

Since standard homeowner insurance does not cover flooding, Congress created the National Flood Insurance Program (NFIP) in 1968. NFIP provides homeowners, renters and business owners some financial protections to flooding if the local community participates in the NFIP. Communities agree to adopt and enforce ordinances that meet or exceed FEMA requirements to reduce the risk of flooding. Federal flood insurance provides reimbursement for flood damage even if a flood has not been declared a federal disaster.

Flood insurance will cover inundation or flooding for homes near a river, stream, or along the coastline. In addition mudflows (defined as movement of the land by viscous water saturated soil) are covered, but landslides are not (for example, movement of the land by earthquakes).

Consider flood insurance if you are at risk of flooding. You may need flood insurance if you live near the coastline, a river, a stream system, or any other body of water. Also, just because you have not experienced a flood in the past, does not mean you may not have a flood in the future. Flood risk is not only based on history, but is a variety of factors such as local rainfall patterns, river flow, and tidal surge data, topography, flood control measures, as well as land use changes due to building and development.

For more information on flood insurance and to see if there is a local insurance agent that offers flood insurance, go to the following website: www.floodsmart.gov/.

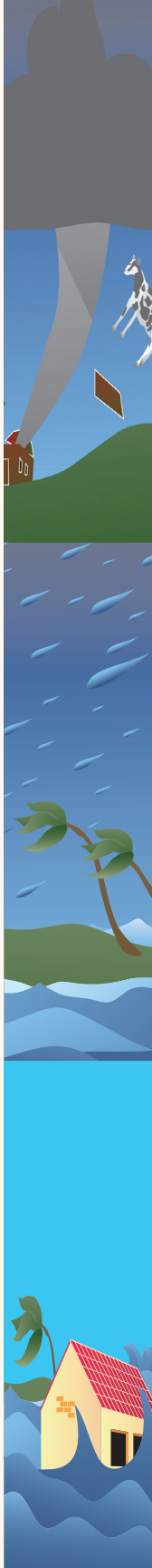



5.3 GENERAL INSURANCE INFORMATION

You buy insurance in the event that a natural disaster damages your property and provides you with resources to aid in your recovery. If you have the unfortunate event that a disaster damages or destroys your home and possessions, to help in this recovery phase, you should have an up-to-date household inventory and insure your valuable records are protected. You will need this information to make an insurance claim following the disaster.

5.3.1 Keeping a Household Inventory and Protecting Valuable Records.³²

Household Inventory

An up-to-date inventory is a valuable resource. This inventory can assist you in determining if you have enough insurance to cover your belongings. Following a disaster, this inventory can help document the value of your lost property for insurance or tax purposes. An inventory should include the following records:

- A description of each item (brand, model, serial number);
- When the item was purchased;
- How much the item cost (how much you paid for it, what is it currently worth, replacement cost).

Make sure you go through every room in your household. Do not forget about your expensive items, as well as your clothes and linens. If possible, include photos and/or a video of these possessions.

Protecting Valuable Records

In the event of a disaster, it is important that you do not lose your personal records. These will be needed for claims, and they are difficult to replace if lost or destroyed. These valuable records can fall into several categories.

- Property: Property records (deeds, titles, leases), household inventory, home improvement, automobile title and bill of sale, certificates for stocks, bonds, etc;
- Financial: Income tax returns, contracts, insurance policies, important receipts and bills of sale, supporting documentation of large transactions, unusual losses, or deductions;
- Identification: Social security cards, citizenship papers, passports, birth certificates, marriage certificates, death certificates;

- Other: Adoption/custody papers, divorce decrees, military service records, retirement papers, religious records, person wills, trust agreements, living wills, powers of attorney, etc.

5.3.2 Making an Insurance Claim³³

There are a number of important steps that you need to take in making an insurance claim following a disaster. These include the following steps.

1. Contact your insurance agency immediately. Provide your agent with your name, address, insurance policy number and the date and time of your loss. Follow up with a letter detailing your losses and keep a copy of the letter for your record. Provide your agent with contact information on where you can be reached, especially if you are unable to stay in your home. Your agent will arrange for an adjuster to visit your property and assess the damage;
2. Document your losses. First step is to be safe. Before entering your property or building, do a physical inspection to determine if there is any structural damage to your home. Be aware of any safety hazards on the property such as downed power lines, gas line leaks, sharp objects or broken glass. Keep power off until an electrician has determined your home electrical system is safe. Following these safety procedures, make a detailed list of lost or damaged property. Videotape or photograph damaged property. Do not throw anything away without your adjuster's approval. Try to document the value of each object lost. (See Part 5.3.1 for keeping household inventory). List cleaning and repair bills. Also, list any additional living expenses you incur following the disaster if your home is damaged so you are unable to occupy it;
3. Protect your property from further damage and theft. Patch any holes in the roof, and cover broken windows. If possible, move household furnishings to safe location for storage. If your house has become flooded, try to clean up your home to protect your family's health as floodwaters can pick up sewage and chemicals from surrounding area. Throw out any food and medicine that may have come into contact with flood waters. Dry out water damaged furnishings and clothes. Remember to save receipts for any costs associated with these efforts;
4. Work with your adjuster. Make sure your adjuster is properly licensed by the state. Be present when the adjuster is on site. Provide your adjuster with inventory of damaged or destroyed items. In discussions, come to an agreement on the scope of damages, which is an agreement in what needs to be repaired and/or replaced without a dollar amount. Make sure you know what needs to be done following this agreement and why;

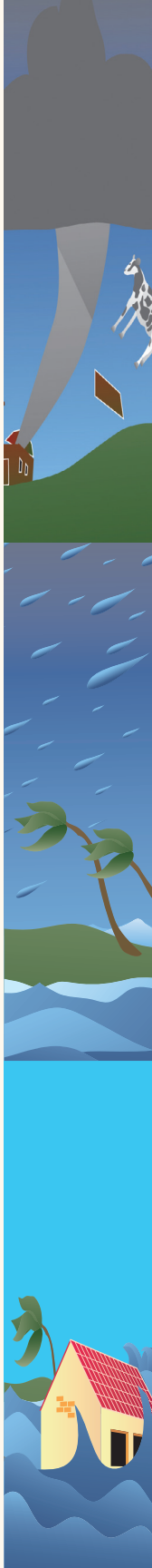



5. Settling your claim. Do not be in a hurry to settle your claims. It is advisable to wait until all the damage has been discovered. Damages overlooked in initial review may become apparent at a later date. You may have separate claims for personal property and structural claims. If you and adjuster can't come to agreement on a settlement, you can obtain mediation through the Florida State Department of Financial Services at www.myfloridacfo.com/;
6. Repairing your home. If you need home repairs, make sure the contractor is licensed and insured. You can find out if the contractor holds a proper license by contact the Florida Department of Business and Professional Regulation www.myfloridalicense.com/. Beware of door-to-door sellers when choosing a contractor to make repairs. Get an written estimate that includes any oral promises the contractor made. Ask if there is a change for an estimate before allowing anyone into your home.

Part 6

Climate Change and Potential Impacts on Natural Hazards

6.1 CLIMATE CHANGE

Today, we are faced with some difficult realities that past generations did not have to contend with. Unfortunately, global climate change is a reality. The question is not if Floridians will be affected by a changing climate, but when we will be affected and in what ways. The potential impacts of climate change on the state's infrastructure, human health, economy, and natural resources are significant.³⁴

First, let us clarify what we mean when we talk about climate. There is frequently confusion between weather and climate. Much of the confusion revolves around time scales. **Weather** (such as air temperature, precipitation, humidity) is measured over a period of days or weeks, while **climate** can be defined as the average weather conditions for a particular region over a 10 to 30 year period. It often is said that “the climate is what we expect; the weather is what we get.” Earth's climate has changed throughout its history, but in timeframes of hundreds and thousands of years. However, during the past century (a much smaller time scale), climate has changed much more rapidly. To date, the world has seen increases in annual average temperatures, increased acidification of the oceans, accelerated rates of sea-level rise, and altered precipitation patterns. Additional climate trends include increases in weather extremes, changes in the onset of seasons, and the melting of glaciers.³⁵

Global climate changes are expected to continue into the future, and the rate of change for many of these variables is expected to increase. Climate scientists agree that human action is contributing to extreme conditions in natural climate variability.³⁶ Fortunately, there are actions that each of us can take to prepare for and minimize the impacts of climate change. This chapter provides an overview of climate change and regional climate trends, describes how these changes may worsen impacts of natural hazards, and provides some steps you can take to make a difference.

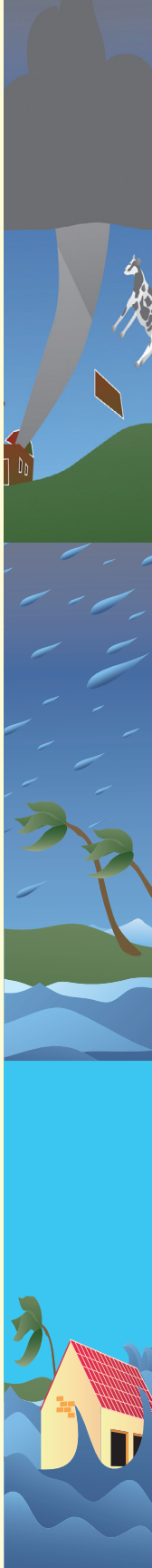



6.2 REGIONAL CLIMATE TRENDS

Climate responds to local, regional, and global conditions. To understand the climate changes that may impact the Southeast United States and Florida specifically, we must first look at the regional geography. Florida is known for its mild and sunny winters, low elevation, 1,350 miles of coastline and nearly 4,500 square miles of estuaries and bays.³⁷ Florida's climate is influenced by latitude, land and water distribution, prevailing winds, storms, atmospheric pressure systems and ocean currents.³⁸

Due to its large expanse (400 miles long from north to south), Florida experiences a wide variety of weather patterns throughout the state. For example, while the southeastern United States as a whole has experienced a 30 percent increase in autumn rainfall since 1901, south Florida has experienced a decline in rain during the fall.

Climate predictions for the Southeast region of the United States includes increased air and water temperatures, decreased water availability, sea-level rise, and likely increased hurricane intensity and associated storm surge. Quality of life will be affected by increasing heat stress, water scarcity, severe weather events, and reduced availability of insurance for at-risk properties.³⁹

6.3 POTENTIAL CLIMATE CHANGE IMPACTS IN FLORIDA

The U.S. Climate Extremes Index indicated that 2012 was the second most extreme year on record for the nation. The Index evaluates extremes in temperature and precipitation, as well as landfalling tropical cyclones. According to NOAA scientists, 2012 was also the hottest year on record in the contiguous United States (See Figure 6-1)⁴⁰. Natural hazards that include coastal storms, floods, droughts, sea-level rise, and wildfires will be affected by the increased warming in the decades ahead. Scientists agree that the severity of these events will intensify. Thus, we need to be prepared with plans and actions that can increase our ability to protect our homes. In the event of major impacts, communities need plan in place to rebuild.

Some climate change impacts such as increased or decreased rainfall and heat waves will occur quickly in response to increasing temperatures. This fast change in extremes is caused by a warmer atmosphere that can hold more moisture. The water cycle intensifies, with both wet (storms) and dry extremes (drought) increasing in both frequency and intensity. Other impacts, such as sea-level rise, will occur on longer time scales from decades to hundreds of years. Some of the potential impacts to coastal storms, floods, drought, extreme temperatures, and seal level rise are outlined in the following sections.⁴¹

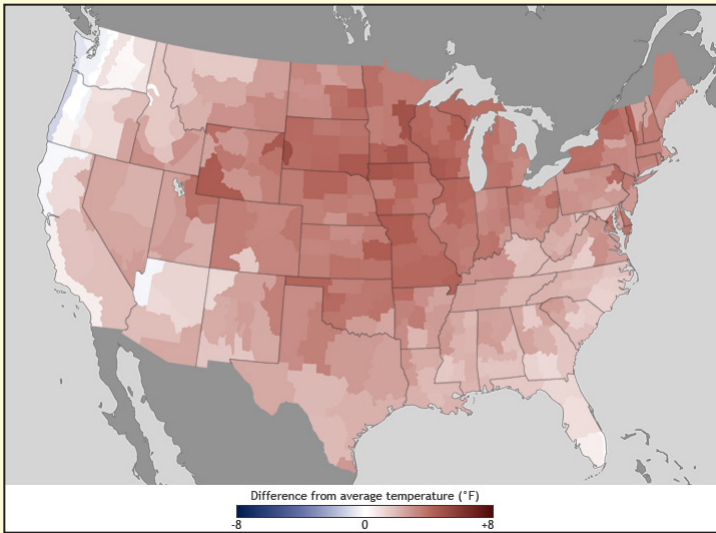

Figure 6-1: Temperature Anomaly 2012 (Source: NOAA)

6.3.1 Coastal Storms

Coastal storms, which can cause flooding, wind, and coastal erosion, can be affected by climate change in several ways. Climate change may affect tropical system intensity, track, size, and/or rainfall. However, the question of future hurricane activity and the probable impacts on Florida is complex and has been the subject of considerable debate in recent years.^{42,43} Some scientists predict the intensity of Atlantic hurricanes is likely to increase during this century with higher peak wind speeds, rainfall intensity, and storm surge height and strength. Although the exact destructive potential of storms depends on a given storm's track, the future threat Florida faces of flooding, erosion, and wind impacts is greater than it is today. It is likely that sea level rise and population growth will increase negative impacts of future rainfall and hurricane activity on infrastructure and water supplies.^{44,45}

6.3.2 Floods and Drought

Throughout the Southeastern United States over the past three decades, while heavy downpours have increased, the percentage of the region experiencing moderate to severe drought has also increased.⁴⁶ With higher sea levels and more intense storms, the probability will rise for major coastal and inland flooding to occur. Coastal flooding will most directly increase due to sea-level rise and higher storm surge impacts. A rise in sea level will intensify the extent of flood damage over time, with areas of lower elevation more susceptible to flooding. Inland flooding will increase due to the changing precipitation patterns (i.e., increased intensity of rainfall events) that are expected for the region.

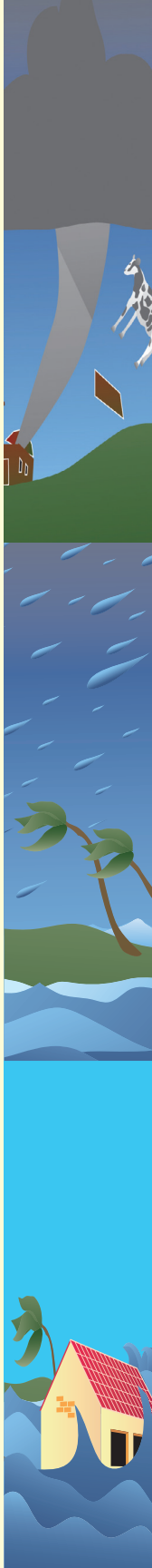

Floods and droughts will impact many sectors of the region's economy.⁴⁷ Increased temperatures and longer periods of time between rainfall events will decrease water availability for communities as well as industry. During droughts, recharge of groundwater aquifer system will decline. As Florida's population increases, additional groundwater pumping will stress or deplete aquifer water levels. This may lead to saltwater contaminating shallow freshwater aquifers in some parts of Florida. There will also be an increased strain on surface water resources. Figure 6-2 shows Florida's population for 2010.

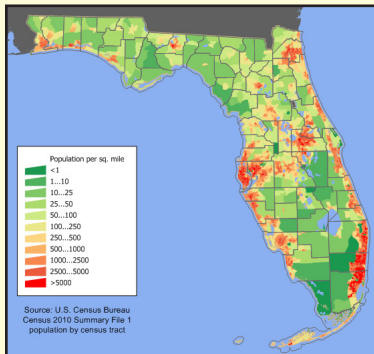

Figure 6-2: Florida population density map based on Census 2010 data
(Source: Jim Irwin at the English Language Wikipedia & U.S. Census Bureau)

6.3.3 Sea-Level Rise

With near 80% of residents living near the coasts, Florida is vulnerable to the potential impacts of sea level rise. Global sea level is rising due to 3 primary sources- thermal expansion of our oceans as the waters warm, melting of polar and high alpine glaciers, and ice loss from Greenland and West Antarctica. Even if we stabilize greenhouse gas emissions, it is projected that global sea level will rise between 20-40 inches and possibly more by 2100.⁴⁸ Sea level rise is already affecting coastal areas and the higher the rise the more costly the damages will be. In addition coastal ridges, roads, public buildings, and utilities are within the areas that could be flooded if sea level rises one foot. As sea level rises, coastal shorelines will retreat and low-lying areas including some communities will be affected with saltwater impacts more frequently. Some existing buildings, infrastructure, and utilities were not designed to withstand additional impacts of the projected storm surge.⁴⁹ In the future, structures, including homes, roads, and utilities that have been built in low-lying areas could become difficult to access, suffer structural instability, or become unusable. Additional effects of sea-level rise include decreased effectiveness of existing coastal structures such as seawalls and revetments. Low-lying areas adjacent to these structures may be subject to increased flooding during storms.

6.4 HAZARD MITIGATION AND CLIMATE CHANGE ADAPTATION

Florida is becoming more vulnerable to increased frequency and intensity of natural hazards resulting. Given Florida's known natural hazard risks and the increasing certainty of climate change impacts, there are a number of reasons for individuals and communities to proactively mitigate natural hazards and adapt to climate change. Because significant time is required to motivate, develop adaptive capacity, and implement changes, acting now will allow for the time needed to achieve these long-term goals. Additionally, many hazard mitigation measures and adaptation strategies that address existing problems, such as short-term impacts of coastal storms, also provide benefits that help in preparing and planning for long-term effects of sea-level rise. Proactive planning is often more effective and less costly than reactive planning and can provide immediate benefits.

6.5 CLIMATE CHANGE. MAKING A DIFFERENCE

So what can you do to protect your family, your property, and your community? The most important actions you can take are participating in mitigation and adaptation.

Mitigation includes actions taken to eliminate or reduce the causes and sources of climate change. Mitigation is most effectively done by reducing carbon dioxide (CO₂) emissions. CO₂ is one of several greenhouse gases that contribute to global warming and climate change (Figure 6-3). The United States is second only to China in terms of CO₂ emissions.

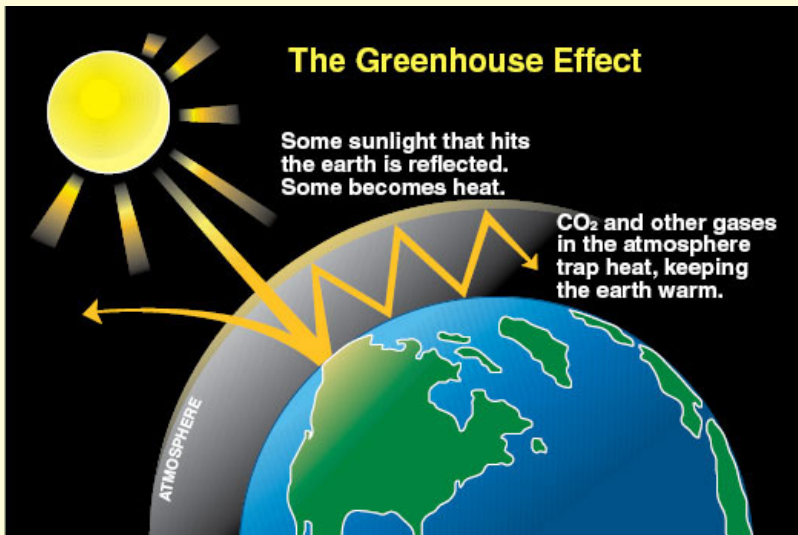



Figure 6-3: Description of the Greenhouse Gas Effect.
(Source: Washington State Department of Ecology)



Making a few small changes in your home and yard can reduce greenhouse gases and save you money. Some simple steps include:⁵⁰

- Replacing light bulbs with CFL or LED lights
- Purchasing Energy Star products
- Using a programmable thermostat
- Insulating your home
- Using water efficiently
- Using Florida Friendly landscaping principles
- Practicing reduce, reuse and recycle

When away from home, you can take additional steps to limiting your carbon footprint including:⁵¹

- Carpooling, walking, biking or utilizing public transportation when possible
- Combining trips for errands
- Maintaining correct tire pressure in your vehicle
- Following your car's maintenance schedule

Adaptation includes actions of individuals, communities, private businesses and governments that decrease the impacts of climate change often proactively, before they happen, which decreases the potential damages. Adaptation plans, discussed in other chapters of this handbook, are actions that people can take to avoid or reduce flooding and coastal hazard risks. Adaptation includes planning for future impacts, avoiding or retreating from areas that may be dangerous, building above flood elevations, water conservation and other measures.

Adaptation actions can include, but are not limited to- protecting home from strong winds by installing window coverings, trimming back trees on your property, strengthening of your roof, and (Parts 4.2, 4.4, and 4.6 respectively); protecting home from high waters by elevating the home itself or “dry floodproofing” your home (Part 4.9.1); and mitigating for fire by clearing brush away from your home, using fire-resistant landscaping and hardening your home with fire-safe construction measures (Part 4.10). FEMA’s Hazard Mitigation Assistance (HMA) program is available for homeowners to implement mitigation measures to existing structures (Part 4.11).

Appendix A

Hurricane Shelters

When a hurricane warning is issued, civil defense information will be released through local radio and television stations and other available means, concerning which shelters will be opened and when. Shelter personnel will be on site to direct you to the specific shelter buildings.

If you are advised to evacuate, try to keep family members together and don't forget your survival kit, including important documents. It is essential that you take your survival kit with you because food, cots, blankets and other comfort items will probably not be available. All three coastal counties use primarily public schools for hurricane shelters. While the counties make every effort to provide sufficient shelter space for expected evacuees; Category 3, 4, and 5 storms threaten many of these shelters, rendering the effected shelters unavailable, resulting in a decrease of shelter space as the hurricane strength increases. It is very important to listen to your local emergency management office if you are considering going to a local public shelter to confirm the shelter will be open.

If you plan to seek a hotel or motel as your shelter in Florida, it would be prudent to make reservations early. Motel rooms tend to fill up quickly when a hurricane is in the Gulf of Mexico.

Prepare an evacuation plan for your pets. Public pet shelters are not yet available. Only service animals are presently allowed in public shelters. For information on how to make an evacuation plan for your pet, visit the following website provided by Florida Division of Emergency Management.

www.floridadisaster.org/petplan.htm

Shelters may be opened selectively depending on the severity of the storm. Should an evacuation become necessary, please listen to your radio or television for up to the minute information on shelters open in your area or log onto the following Florida Red Cross websites for hurricane shelters:

American Red Cross - www.redcross.org/find-help

When you arrive at your shelter, please follow Red Cross directions for the appropriate room or building.

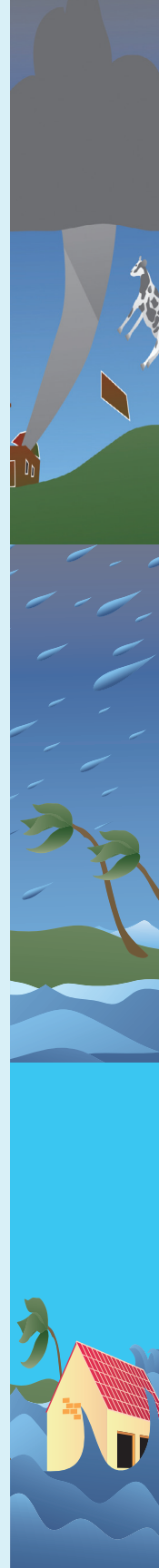



Hurricane Shelters

A list of Hurricane shelters by county can be found online at:
www.floridadisaster.org/shelters/.

What to bring to a shelter?

Water and food:

Water - one gallon of water per person, per day.

Food - Non-perishable, needing little or no cooking, such as ready-to-eat meats, fruits, vegetables and canned juices. High energy foods such as peanut butter, jelly, crackers, granola bars, trail mix and other snack foods. Special dietary foods - such as diabetic, low salt, liquid diet and baby food and formula. Manual can opener. Eating and drinking utensils including paper plates. Portable ice chest with ice.

Clothing and bedding:

One complete change of clothing including footwear. Sleeping bag, blanket and pillow (cots for elderly) - cots will not be provided. Rain gear and sturdy shoes.

Personal items:

Washcloth, small towel, soap, toothbrush, toothpaste, sanitary napkins, tampons, paper towels, toilet paper, towelettes, etc.

Medications, first-aid supplies:

Medications - clearly marked with your name, dosage, type of medication and prescribing physician. You must be able to take all medications by yourself. First-Aid kit in a waterproof box.

Baby supplies:

Clothes, diapers, formula, bottles, nipples, food, blankets.

Important documents and information:

Name and address of doctors. Name and address of nearest relative not living in affected area. Identification and valuable documents.

Miscellaneous:

Games, cards, toys, battery powered radios, flashlights (no candles or lanterns), batteries, or other reasonable items you may need.

Remember...

Take a bath and eat before you leave home.

Register immediately upon entering the shelter.

Obey shelter rules.

Keep the building safe and sanitary.

NO pets, alcoholic beverages, or weapons are allowed.

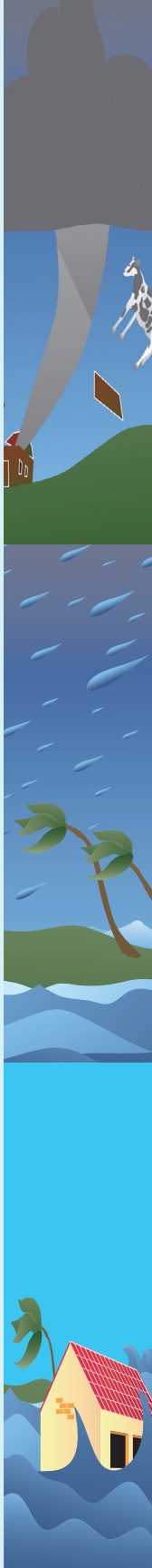

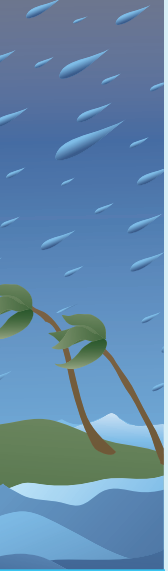

Appendix B

Emergency Contact Information

Please contact the Florida Emergency Information Line (Toll Free 1-800-342-3557) before attempting to contact your local emergency manager in times of emergency!

| FLORIDA COUNTY EMERGENCY MANAGEMENT OFFICES | | | |
|---------------------------------------------|-------------------------|------------|----------------|
| COUNTY | PHONE NUMBER | COUNTY | PHONE NUMBER |
| ALACHUA | (352) 264-6510 | LEE | (239) 533-3620 |
| BAKER | (904) 259-6111 | LEON | (850) 488-5921 |
| BAY | (850) 248-6040 | LEVY | (352) 486-5213 |
| BRADFORD | (904) 966-6336/6337 | LIBERTY | (850) 643-3477 |
| BREVARD | (321) 637-6670 | MADISON | (850) 973-3698 |
| BROWARD | (954) 831-3900 | MANATEE | (941) 749-3505 |
| CALHOUN | (850) 674-8075 | MARION | (352) 369-8100 |
| CHARLOTTE | (941) 833-4000 | MARTIN | (772) 219-4942 |
| CITRUS | (352) 746-6555 | MIAMI-DADE | (305) 468-5400 |
| CLAY | (904) 284-7703 | MONROE | (305) 289-6065 |
| COLLIER | (239) 252-3600 | NASSAU | (904) 548-4980 |
| COLUMBIA | (386) 758-1125 | OKALOOSA | (850) 651-7150 |
| DESOTO | (863) 993-4831 | OKEECHOBEE | (863) 763-3212 |
| DIXIE | (352) 498-1240 EXT. 224 | ORANGE | (407) 836-9140 |
| DUVAL | (904) 630-2472 | OSCEOLA | (407) 742-9000 |
| ESCAMBIA | (850) 471-6409 | PALM BEACH | (561) 712-6321 |
| FLAGLER | (386) 313-4246 | PASCO | (727) 847-8137 |
| FRANKLIN | (850) 653-8977 | PINELLAS | (727) 464-5550 |
| GADSDEN | (850) 875-8642 | POLK | (863) 534-5605 |
| GILCHRIST | (386) 935-5400 | PUTNAM | (386) 329-0379 |
| GLADES | (863) 946-6020 | SANTA ROSA | (850) 983-5360 |
| GULF | (850) 229-9110 | SARASOTA | (941) 861-5495 |
| HAMILTON | (386) 792-6647 | SEMINOLE | (407) 665-5017 |
| HARDEE | (863) 773-6373 | ST. LUCIE | (772) 462-8100 |
| HENDRY | (863) 674-5400 | ST. JOHNS | (904) 824-5550 |
| HERNANDO | (352) 754-4083 | SUMTER | (352) 569-1660 |

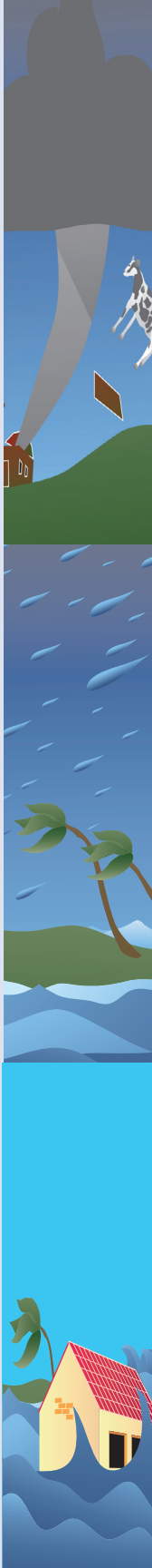

| | | | |
|--------------|----------------|------------|-----------------------|
| HIGHLANDS | (863) 385-1112 | SUWANNEE | (386) 364-3405 |
| HILLSBOROUGH | (813) 236-3800 | TAYLOR | (850) 838-3500 EXT 7 |
| HOLMES | (850) 547-1112 | UNION | (386) 496-4300 |
| INDIAN RIVER | (772) 226-3859 | VOLUSIA | (386) 254-1500 X 1505 |
| JACKSON | (850) 718-0007 | WAKULLA | (850) 745-7200 |
| JEFFERSON | (850) 342-0211 | WALTON | (850) 951-4721 |
| LAFAYETTE | (386) 294-2847 | WASHINGTON | (850) 638-6203 |
| LAKE | (352) 343-9420 | | |

ADDITIONAL EMERGENCY CONTACTS

| | | |
|----------------------------------------------------------------|--|-----------------------------------|
| AMERICAN RED CROSS | | 1-866-GET-INFO (1-866-438-4636) |
| | | WWW.REDCROSS.ORG/FIND-HELP |
| FEDERAL EMERGENCY MANAGEMENT AGENCY (FEMA) | | 1-800-621-FEMA (1-800-621-3362) |
| | | WWW.FEMA.GOV/ |
| FLORIDA DIVISION OF EMERGENCY MANAGEMENT (FDEM) | | 1-850-413-9969 |
| | | WWW.FLORIDADISASTER.ORG/INDEX.ASP |
| FLORIDA DEPARTMENT OF TRANSPORTATION (FDOT) | | 1-866-347-FDOT (1-866-347-3368) |
| | | WWW.DOT.STATE.FL.US/ |
| FLORIDA DEPARTMENT OF HIGHWAY SAFETY & MOTOR VEHICLES (FDHSMV) | | 1-850-617-2000 |
| | | WWW.FLHSMV.GOV/ |

LODGING INFORMATION

| | | |
|---------------------------------------------------|--|-----------------------|
| FLORIDA DEPARTMENT OF ECONOMIC OPPORTUNITY (FDEO) | | 1-850-245-7105 |
| | | WWW.FLORIDAJOBS.ORG/ |
| FLORIDA TOURISM | | 1-866-972-5280 |
| | | WWW.VISITFLORIDA.COM/ |

CAMPGROUND INFORMATION

| | | |
|------------------------------|--|----------------------------|
| FLORIDA STATE PARKS | | 1-850-245-2157 |
| | | WWW.FLORIDASTATEPARKS.ORG/ |
| KAMPGROUNDS OF AMERICA (KOA) | | 1-888-562-0000 |
| | | WWW.KOA.COM/ |
| CAMP GROUNDS.COM | | WWW.CAMP GROUNDS.COM/ |

| ANIMAL SHELTERS | |
|----------------------------------------|----------------------------------------------------------------------------------|
| THE FLORIDA HUMANE SOCIETY | 1-954-974-6152 |
| | WWW.FLORIDAHUMANESOCIETY.ORG/ |
| FLORIDA VETERINARY MEDICAL ASSOCIATION | WWW.FVMA.ORG/ |

| INFORMATION FROM SURROUNDING STATES | |
|--------------------------------------------------------|----------------------------------------------------------------------|
| GEORGIA EMERGENCY MANAGEMENT AGENCY/ HOMELAND SECURITY | 1-800-TRY-GEMA (1-800-879-4362) |
| | WWW.GEMA.STATE.GA.US/ |
| GEORGIA TOURISM | 1-800-VISIT-GA (1-800-847-4842) |
| | WWW.EXPLOREGEORGIA.ORG/ |
| STATE OF ALABAMA EMERGENCY MANAGEMENT | 1-205-280-2200 |
| | WWW.EMA.ALABAMA.GOV/ |
| ALABAMA TOURISM DEPARTMENT | 1-800-ALABAMA (1-800-252-2262) |
| | WWW.ALABAMA.TRAVEL/ |

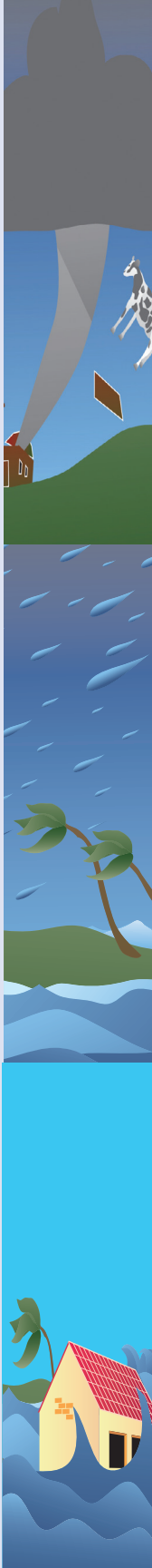

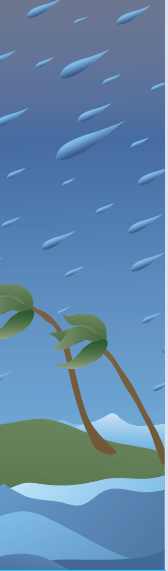

Appendix C

Beach Management, Construction at the Coast, and Coastal Property Checklist

BEACHES IN FLORIDA

Florida boasts approximately 825 miles of open coast beaches fronting on the Atlantic Ocean, Straits of Florida and Gulf of Mexico. Florida also has many miles of shorelines in bays, inlets and sheltered islands, in addition to the open coast beaches (Figure C-1). More than 60% of Florida's population lives within 10 miles of the coast. Shorelines contain vital ecosystems that are home to many species of plants and animals that vary around the state; many rare, threatened, and endangered. These species, including nesting shorebirds and sea turtles, rely on specific characteristics in these ecosystems. For example, shorebirds begin to migrate to Florida beaches in early spring through summer to nest. Also, during the months from April to October, sea turtles come on shore to dig their nesting areas. Six of the seven worldwide species of sea turtles nest on Florida beaches. Nesting populations are closely monitored around the state.



Figure C-1: Beachfront in Pensacola Beach, Florida. (Source: Lampl Herbert Consultants)



Some of the State's open coast beaches are experiencing erosion of the shoreline where natural processes or human activity have caused or contributed to erosion and loss of the beach or dune system. Storm waves may cause erosion of beaches and dunes or may break through dunes, pushing sand inland. In some places erosion happens to such a degree that upland development, recreational interests, wildlife habitat, or important cultural resources are threatened or lost. Coordination of federal, state, and local agency activities is necessary to address coastal erosion and storm damage to beaches and coastal shorelines. The Florida Department of Environmental Protection (FDEP) and the Florida Fish and Wildlife Conservation Commission (FWC) are the primary state agencies with responsibilities for coastal shoreline, habitat and species management and protection. Federal government agencies that assist the state include the U.S. Army Corps of Engineers (USACE), National Oceanic and Atmospheric Administration (NOAA), Federal Emergency Management Agency (FEMA), and the U. S. Department of the Interior (DOI). The need for a comprehensive, coordinated, and proactive approach to shoreline management is emphasized by numerous factors. The coast is actively changing and moving; storm activity can, and very often does, dramatically alter the coast; and coastal population and development continues to increase. Florida's comprehensive planning and regulatory programs continue to evolve with coastal science and general understanding of processes that impact all aspects of the coast. The science and management tools for shore protection have generally focused on building structures designed to protect buildings (seawalls and bulkheads), but more recently include practices that protect and enhance natural beaches and shorelines (construction setbacks, dune protection and living shorelines).

DUNES AND DUNE MANAGEMENT

Sand dunes—ridges or mounds of windblown sand—are an integral part of Florida's beach system. Dunes are vital to shoreline stability because they are protective features that also serve as reservoirs for sand. They are resilient natural barriers to the destructive forces of coastal storms and offer the most efficient defense against flooding tides and waves.⁵²

Coastal storms can destroy even well-established dunes, which is a function of these features. During storms, high-energy waves may wash against the base of the dunes, eroding sand and undermining the seaward dune face. In extreme storms, the dune face may recede significantly and the dune itself may be destroyed. During storm events, dune sand and vegetation are removed and the sand is redistributed along the beach. Essentially, the dunes act as a sand storage system and a buffer between the ocean and coastal property. Depending on the size of the dune and intensity of the storm, high continuous dunes can provide a barrier to storm surge and overwash, thereby reducing flooding on the landward side.

Natural dune recovery after a storm depends on the severity of the storm and the initial condition of the dune. The foredunes can become severely eroded, completely flattened or overtopped during a storm. In the days and weeks after a storm, waves begin to push sand from nearshore bars back to shore to rebuild the beach. Eventually sufficient sand returns to the beach, and the dune begins to recover from storm damage as the wind blows sand up into the dune area. Natural dune rebuilding processes operate relatively slowly. Left solely to natural processes, dunes may take years or even decades to recover after a severe storm. Dune vegetation, particularly Sea Oats (*Uniola paniculata*) are key to the stability of the dune system and the rebuilding process. These grasses are adapted to recover after the dune system gets destroyed and the rebuilding process starts over. The system of fibrous roots and rhizomes helps hold the sand and provides dune stability.

The typical dune system includes a foredune (dunes closest to the ocean), secondary dune (large dunes covered in woody vegetation behind the foredune system) and coastal hammocks or scrub (the part of the dune system furthest away from the ocean) (Figure C-1). The system as a whole provides protection to interior areas. However this system is fragile and needs to be protected in order to allow the natural processes to work.

Figure C-2: Dune system found on barrier islands characterized by a beach zone, foredune, and secondary dunes.⁵³
(Source: McGraw-Hill Access Science)

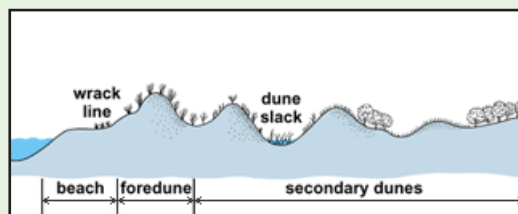

There are many ways for individuals and communities to help protect Florida dune systems:

- Allow beach grass and dune vegetation to grow naturally. Mowing destroys the grasses' ability to trap sand and may kill the plants and destroy animal habitat.
- Sea Oats are protected in Florida and picking, disturbing or removing from public lands or without owner's permission is prohibited and punishable by fine.
- Use designated dune walkovers and access points to control pedestrian and vehicular traffic flow across dunes. All planted areas should be protected from vehicles, pedestrians, and pets.
- Restore damaged dunes, plant vegetation,⁵⁴ and rope off area's to restrict traffic. Do not remove any material from the dune—all sand and vegetation should remain on the dune and beach system.

- 
- Refer to the for dune planting recommendations in a coastal environment.⁵⁵
 - Place signs on the dune to explain the importance of keeping off of the beach grass and dunes.
 - Avoid hard landscaping such as railroad ties, flower boxes, retaining walls, piling tops, large stone, brick, cement blocks, and concrete. These items should not be placed in dune environments. They are easily lifted by storm waves, becoming debris that can batter your home and adjacent buildings and may cause severe damage or loss of property.
 - Maintain a clear, clean, and natural dune environment. Items such as Christmas trees, cut shrubs, and yard clippings will smother natural dune vegetation, can be obstacles for sea turtles and may also become a fire hazard. This type of debris should not be placed on the dune or beach. Similarly, items such as cars, trucks, bikes, and boats should be kept off of the dune.

CONSTRUCTION AT THE COAST

If you are a coastal property owner, it's important to know about the dynamic processes that shape Florida's shorelines as well as the potential risks and consequences of living at the coast. Most properties along the oceanfront, barrier islands, bays, intercoastal waterway, marshes, and tidal rivers are vulnerable to coastal hazards such as storms, erosion, sea-level rise, and flooding (Figures C-3 and C-4). Property owners should become aware of potential impacts and risks associated with living at the coast. Some basic considerations are included in this section.

Studies by the FEMA and other organizations after major coastal disasters have consistently shown that properly sited, well-designed, and well-constructed coastal residential buildings generally perform well. An excellent source of information for protecting your property at the coast is found in FEMA's Coastal Construction Manual (FEMA P-55) available on FEMA's Library website at www.fema.gov/library/index.jsp. This manual was prepared by FEMA with assistance from other agencies, organizations, and professionals involved in coastal construction and regulation, to help designers and contractors. The manual identifies and evaluates practices that will improve the quality of construction in coastal areas and reduce the economic losses associated with coastal disasters.



Figures C-3 & C-4: Beachfront properties at Cape San Blas following Hurricane Dennis.
(Source: Rosalyn Kilcollins)



Additional coastal construction resources and publications are available on FEMA's website (www.fema.gov/residential-coastal-construction), including:

- National Flood Insurance Program Technical Bulletins;
- Home Builder's Guide to Coastal Construction (FEMA P-499);
- Recommended Residential Construction for Coastal Areas: Building on Strong and Safe Foundations (FEMA P-550);
- Local Official's Guide for Coastal Construction (FEMA P-762);
- Wind Retrofit Guide for Residential Buildings (FEMA P-804); and
- Protecting Manufactured Homes from Floods and Other Hazards (FEMA P-85).

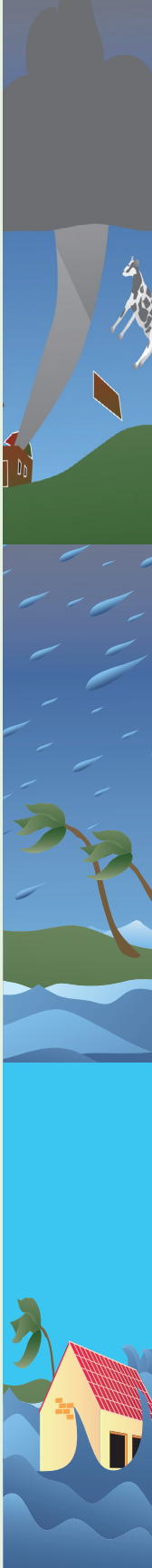



In Florida the effort to balance protection of Florida beaches and reasonable use of private property, led to the creation of the Coastal Construction Control Line (CCCL) Program by the Florida Legislation in 161.053 F. S. The line is set for sandy beaches in 25 counties along Florida’s Atlantic and Gulf Coasts. The CCCL Program aims to ensure proper siting and design of structures in order to minimize damage to local beach and dune systems, adjacent properties, public beach access and nesting sea turtles. No construction may take place seaward of the CCCL without a coastal construction permit from the FDEP. The CCCL environmental protections are in addition to coastal building zone structural design requirements of the Florida Building Code, Section 3109. The coastal building zone is the area from the “seasonal high water line” landward up to 1,500 feet and on barrier islands to 5,000 feet landward of the CCCL. Special siting and design standards are applied for construction and related activities seaward of the CCCL. These standards are often more stringent than those applied in the rest of the coastal building zone Go to www.floridadep.org/beaches for more information or contact a FDEP representative within the CCCL Program at (850) 488-7708.

County and municipal governments may have additional requirements for building setbacks and dune protection. It is important to check with local planning and building departments for guidelines specific to your area.

DO’S AND DON’TS

Do:

- Learn how the shoreline changes, day to day and decade to decade.
- Learn about local coastal processes, wave conditions, and how the beach changes seasonally from the planning department, residents in the area and other local resource contacts. The beach can look very different in February and March than it does in August and September. For properties seaward of the CCCL, contact FDEP to find out the shoreline erosion rate and height of storm wave.
- Ask local building, emergency management or floodplain staff whether the land has experienced flooding in the past, including any details such as how high the water was and if waves washed over the property.
- Contact local building or code enforcement staff to determine whether all buildings meet current FEMA, FDEP and Coastal Building Zone requirements.
- Locate all structures and improvements well away from the shoreline according to setback requirements and floodplain maps to allow the beach space to migrate as well as minimize risks from coastal hazards.

- Contact local building or code enforcement staff and area realtors to find out about the history and status of any shoreline structures on the property and confirm their legality. New homeowners assume responsibility for existing structures whether they are legal or not.
- If the property has signs of shoreline erosion occurring, consider alternative erosion management measures, such as living shorelines which use native plants to stabilize the shore, Maintain the natural dune features and native plants around the shoreline area.

Don't:

- Build structures that do not conform to the applicable building codes or meet permitting requirements within a high hazard coastal zone where they are likely to be threatened by waves or erosion.
- Assume the shoreline is stable just because it looks wide.
- Assume you will be granted authorization for a shoreline structure or restoration just because the shoreline is eroding. There are specific criteria that must be met in order to obtain permission for shoreline structures and/or restoration.
- Alter, grade, trample on, or reduce the height of the coastal dune.

COASTAL PROPERTY CHECKLIST

If you live along the immediate coast, you are more vulnerable to the effects of coastal storms. High winds and waves may damage and destroy improperly constructed homes. Floating or flying debris can crack foundation piles, causing collapse of the home or severe damage to windows and doors. Pressure from floodwaters on solid foundations can lead to collapse.

You can prevent or minimize damage by taking precautions during initial construction or by making modifications to an existing home. The following checklist is not all-inclusive and is not intended to replace local building code requirements or to serve as the only options for protecting your home from storm damage. For more information, contact your local building official or a building professional such as a coastal engineer, architect, or experienced contractor.

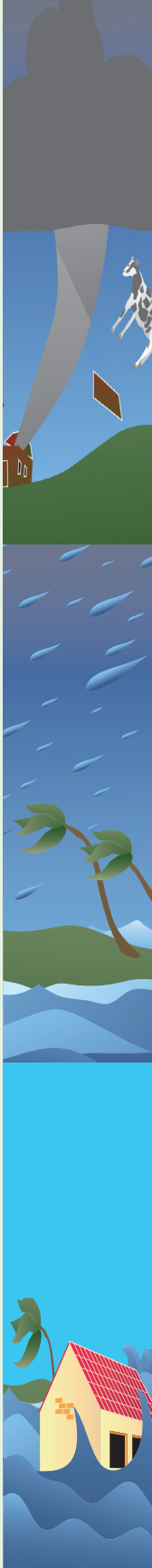



FLOODING: Visit www.floodsmart.gov for information and assistance

- Do you know the projected flood elevation for your area? Ask your building department to see a flood map of your community or visit the FEMA online flood map site.
- Is the first floor of the dwelling located above the projected flood elevation for your area?
- Is your home located in a V zone? Areas in a V zone have the potential for waves of three feet or greater above flood levels in a storm event. Retaining walls, bulkheads, or other soil management structures located underneath, connected to, or in close proximity to existing or proposed buildings are generally prohibited within V zones.
- If your house is elevated on piles, do you have an open foundation, free of obstruction, that allows fast-moving waves and water to flow beneath the building?
- If storage areas or other enclosures are needed below projected flood elevations, they must be constructed with breakaway walls to allow water to flow through unobstructed. Is your enclosure breakaway?
- Are steps used for getting to the beach from the structure or dune crossovers elevated or located out of the reach of waves and floodwaters?
- Are the main electric panel, outlets, and switches located at least 12 inches above potential floodwaters?
- Are the washer, dryer, furnace, and water heater elevated above potential floodwaters?
- Are outside air-conditioning compressors and heat pumps elevated above expected flood levels?
- Are all hazardous materials, such as gas cans or tanks, fertilizer, paint, pesticides, etc., stored above expected flood levels?
- What is the orientation of crossbracing on the pilings? Diagonal bracing will obstruct velocity floodwaters and waves and will often trap debris, therefore bracing is often placed parallel to the primary direction of flow. Check with your architect or engineer.
- Does the sewer have a backflow valve? Contact a licensed plumber to install the valve.
- Are there potential projectiles such as landscaping ties, cinder blocks, cement patio blocks, pile butts, planted trees, or split rail fences located in the pathway of waves and flood waters? These objects can crack and damage piles and lower level enclosures, causing possible collapse of the structure.

WIND

- Are windows and exposed glass surfaces protected by coverings? This is one of the best ways to protect your home against wind and flying debris.
- Is the roof fastened to the walls with galvanized metal hurricane clips? This will reduce the risk of losing your roof to high winds.
- Are the galvanized clips, straps, hangers, and joist-to-beam ties corrosion free? Corroded metal components can fail during extreme wind events. These should be replaced when corroded.
- Are the foundation piles notched less than 50 percent of the pile cross section? Overnotching can lead to failure of the piles.
- Are deck and lawn furniture, which are likely to become airborne debris, securely fastened or taken indoors?
- Hip versus gable or flat roof?

EROSION

- Are your foundation piles deep enough (according to code requirements and CCCL requirements) to survive a coastal storm?
- Do you know the estimated long-term erosion rates for your area? Are any actions such as beach nourishment or other erosion control projects being implemented to mitigate long-term erosion?
- Is your property protected by a maintained beach and dune system project? Is that project currently being maintained to its intended design? Is the dune in front of your home well vegetated to prevent wind erosion? Is the dune of sufficient height and width to prevent overtopping by waves during a storm?
- Are there bare, low areas in the dune created by walking over the dune to access the beach? These areas are weak spots that will allow waves to flow over the dune and cause loss of the dune and subsequently allow waves and water into the house.
- Do not undertake any dune alteration activity unless a proper engineering analysis demonstrates that there will be no increase in flood risk. All restoration work must include beach compatible sand and be approved and permitted by FDEP for properties seaward of a CCCL.
- Is your home built on a concrete slab and located on the ocean or bay front? Concrete slabs can be undermined and destroyed during storms, causing the collapse of the structure. Crawl-space homes are also vulnerable to undermining. If possible, elevate the structure on pilings.

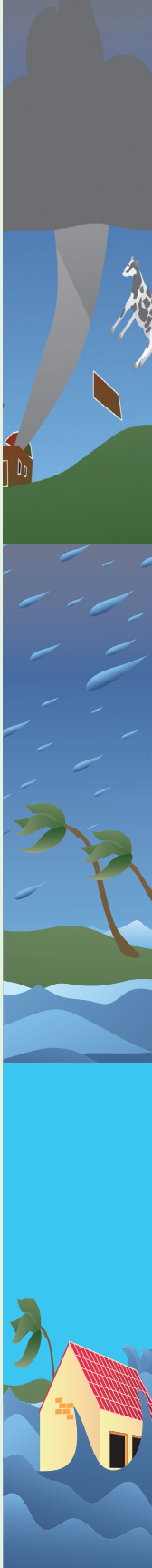



- Does your home have a septic system located in a coastal high-hazard area (V zone)? Both buried and mound septic systems are frequently exposed, destroyed, or displaced during coastal storm events. Special design criteria must be used to protect septic systems in areas vulnerable to high-velocity flooding, wave action, erosion, and storm damage. For more information contact your local or state health department officials before beginning work.

STRUCTURAL

- Is the structure seaward of the CCCL? If so, does it meet the CCCL structural design and elevation requirements?
- If the structure is landward of the CCCL, does it meet the Florida Building Zone structural design and elevation requirements?
- Inspect strapping and connectors for corrosion and replace if necessary.
- Check roof for loose or missing shingles. Be certain gutters are clear of debris.
- Inspect condition of storm shutters or plywood used to protect windows and doors prior to the beginning of hurricane season. When a hurricane warning goes into effect for your area, cover all large windows and doors (especially patio doors) with securely fastened, impact-resistant shutters with proper mounting fixtures.
- Make sure all doors and windows are caulked and/or weather stripped.
- Inspect sewer backflow valves for proper functioning.
- Inspect condition of elevated utilities and supporting platforms. Be sure utilities are securely anchored to the supporting frame.

LOT AND LAND AREA

- Remove, secure, or store any objects that may be carried by waves or winds (e.g., deck furniture, landscaping, construction materials, etc.).
- Raise or remove steps accessing the beach.
- Check condition of dune (width and elevation). Inspect condition of beach grass. Replant bare areas with natives in the spring.
- Trim back dead or weak branches from trees and prune thick growth to allow wind to pass through if necessary.
- Use walkover and landscape guidelines. When constructing dune walkovers across native beaches and vegetation use post-supports and elevate high enough above the existing or proposed vegetation to allow for sand build-up and for clearance above the vegetation. Be sure to get any required permits before starting construction.⁵⁶

Appendix D

Preparedness Checklists

This section contains the following checklists:

1. Home Inspection Checklist
2. Disaster Supply Kit Checklist
3. First Aid Kit Checklist
4. Pet Disaster Safety Checklist

HOME INSPECTION CHECKLIST

The following suggestions will reduce the risk for injury during or after a tornado. No amount of preparation will eliminate every risk.

Possible Hazards

- Inspect your home for possible hazards, including the following:
- Are walls securely bolted to the foundation?
- Are wall studs attached to the roof rafters with metal hurricane clips, not nails?

Utilities

- Do you know where and how to shut off utilities at the main switches or valves?

Home Contents

- Are chairs or beds near windows, mirrors, or large pictures?
- Are heavy items stored on shelves more than 30" high?
- Are there large, unsecured items that might topple over or fall?
- Are poisons, solvents, or toxic materials stored safely?

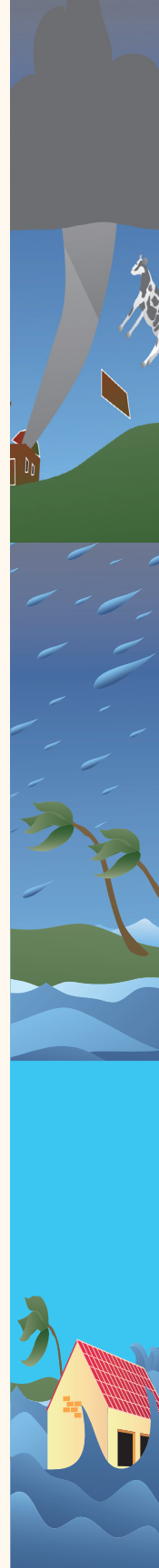



DISASTER SUPPLY KIT CHECKLIST (www.floridadisaster.org)

- Water – at least 1 gallon daily per person for 3 to 7 days
- Food – enough for at least 3 to 7 days
 - non-perishable packaged or canned food and beverages
 - snack foods
 - foods for infants or those with strict diets
- Non-electric can opener, paper plates, plastic utensils, plastic cups
- Cooking tools, grill, fuel, charcoal, and matches
- Blankets, pillows, sleeping bags, etc.
- Clothing – seasonal/rain gear/ sturdy shoes or boots
- First Aid Kit, prescriptions, medications, sun screen, aloe and bug spray
- Special items for babies, the elderly, and persons with disabilities
- Toiletries – hygiene items and sanitation wipes
- Flashlights and batteries – do not use candles
- Extra house and car keys, office keys and name badges
- Cash – banks and ATMs may not be available after a storm
- Radio – battery operated or hand cranked radio, and NOAA weather radio
- Keys
- Toys, books and games
- Important documents in a waterproof envelope ; include insurance cards, medical records, bank account numbers, credit card numbers, Social Security cards, birth and marriage certificates, etc.
- Document all valuables
- Tools – keep a set with you during the storm
- Vehicle – keep your motor vehicle fuel tanks filled
- Pet care items – pet food and water, proper identification, medical records, a carrier or cage, muzzle and leash, medications

FIRST AID KIT CHECKLIST

A well-stocked first aid kit is a handy thing to have. To be prepared for emergencies, keep a first aid kit in your home and in your car. Whether you buy a first aid kit or put one together, make sure it has all the items you may need. Include any personal items such as medications and emergency phone numbers or other items your health-care provider may suggest. Check it regularly to ensure flashlight batteries work, and to check expiration dates replacing any used or out-of-date contents.

The Red Cross recommends that all first aid kits for a family of four include the following:

- 2 absorbent compress dressings (5 x 9 inches)
- 25 adhesive bandages (assorted sizes)
- 1 adhesive cloth tape (10 yards x 1 inch)
- 5 antibiotic ointment packets (approximately 1 gram)
- 5 antiseptic wipe packets
- 2 packets of aspirin (81 mg each)
- 1 blanket (space blanket)
- 1 breathing barrier (with one-way valve)
- 1 instant cold compress
- 2 pair of non-latex gloves (size: large)
- 2 hydrocortisone ointment packets (approximately 1 gram each)
- Scissors
- 1 roller bandage (3 inches wide)
- 1 roller bandage (4 inches wide)
- 5 sterile gauze pads (3 x 3 inches)
- 5 sterile gauze pads (4 x 4 inches)
- Oral thermometer (non-mercury/ non-glass)
- 2 triangular bandages
- Tweezers
- First aid instruction booklet

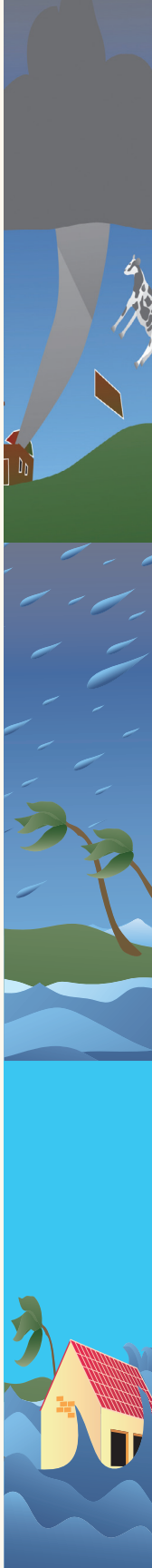



© Copyright The American National Red Cross. All rights reserved.

Special Note: Aspirin are for adults only. Check with your doctor to make sure you can take aspirin. Remember to add special need items for you or others in your home.

Information retrieved March 5, 2013 from: www.redcross.org/prepare/location/home-family/get-kit/anatomy.

PETS AND DISASTER SAFETY CHECKLIST

- List of important telephone numbers – including your county emergency management office, evacuation sites, doctors, bank, area schools, veterinarian, etc.
- Plan to take your pets with you in an evacuation, it is not safe to leave them home.
- Have pet ID (#1 Priority)
- Photo off you and your animal (this will help with identification and proof of ownership)
- Important records and papers (immunization records, health records, bill of sale papers, registration papers)
- List of Pet-Friendly hotels & local shelters if applicable (compile this in advance)
- Evacuation Route (based on location of chosen hotel and shelter)
- Food, water and medications (enough for 7 days)
- First Aid Kit
- Leashes, carriers, muzzle (even if your pet is normally obedient, pets can act differently during and after a storm)

Refer to www.redcross.org/images/MEDIA_CustomProductCatalog/m3640126_PetSafety.pdf for more safety information for before and after the storm. Remember all emergency family plans need to include your pets.

Endnotes

- 1 “Florida Hazard Watch – Tornadoes.” Accessed March 2013 from the World Wide Web: <http://www.floridadisaster.org/EMTOOLS/Severe/tornadoes.htm>.
- 2 “Florida Tornadoes - Hazard Recognition..” Florida Disaster Center. Accessed March 2013 from the World Wide Web at <http://www.disastercenter.com/florida/tornado.html>. Last Accessed March 7, 2013.
- 3 “Thunderstorm Hazards – Tornados.” National Weather Service website. January 5, 2010. Accessed May 2010 from the World Wide Web: <http://www.srh.weather.gov/data/www/html/srh/jetstream/tstorms/tornado.htm#ef>.
- 4 “The Tornado Project.” Fujita Scale of Tornado Intensity website. 1999. Accessed May 2010 from the World Wide Web: <http://www.tornadoproject.com/fscale/fscale/htm>.
- 5 Source: Florida Divisions of Emergency Management: <http://www.floridadisaster.org/index.asp>
- 6 Source: Keeping a Household Inventory an Protecting Valuable Records. Michael Olexa and Travis Walker. (2012). UF IFAS Extension. University of Florida. Publication DH138.
- 7 “Freeboard.” Storm Smart Coasts-Mississippi website. Updated May 25, 2010. Accessed May 28, 2010 from the World Wide Web: <http://ms.stormsmartcoasts.org>.
- 8 “Emergency Alert System Plan.” Florida Association of Broadcasters, Inc. & Florida Division of Emergency Management. Revised Feb 1, 2013. Accessed March 2013 from the World Wide Web at http://www.fab.org/Docs/2013EAS/State_of_Florida_EAS_Plan_Revised_2.4.pdf.
- 9 “Emergency Preparedness and Response for Tornadoes.” Centers for Disease Control and Prevention. Accessed March 2013 from the World Wide Web at <http://emergency.cdc.gov/disasters/tornadoes/prepared.asp>.
- 10 “North Central Florida Extreme Weather Information Sheet.” NOAA National Coastal Data Development Center. Revised 2013. Accessed March 2013 from the World Wide Web: <http://www.ncddc.noaa.gov/activities/weather-ready-nation/newis/>.
- 11 “Protecting You Where You Live.” Institute for Business and Home Safety (IBHS) website. Accessed May 2010 from the World Wide Web: http://www.disastersafety.org/text.asp?id=hurricane_media.
- 12 “Mitigation Directorate.” FEMA website: Accessed April 2013 from the World Wide Web: <http://www.fema.gov/safer-stronger-protected-homes-communities>.
- 13 Institute for Business & Home Safety. 1998. “Is Your Home Protected from Hurricane Disaster?—A Homeowner’s Guide to Retrofit.”

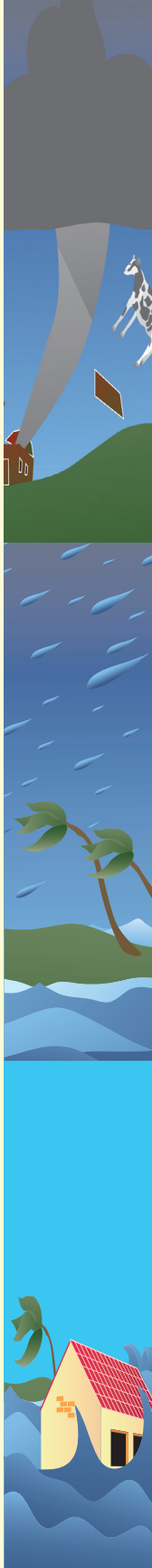



- 14 "Coastal Construction Manual." FEMA. 2000.
- 15 "Testing Application Standard (TAS) No. 100(A)-95." Florida Building Code. 2010. Accessed April 2013 from the World Wide Web: http://www.ecodes.biz/ecodes_support/free_resources/2010Florida/TestProtocols/PDFs/Testing%20Application%20Standard%20No_100A-95.pdf.
- 16 "Hurricane Proofing Installation." International Hurricane Protection Association website. Copyright 2009. Accessed from the World Wide Web: <http://www.inthpa.com>.
- 17 "Window Film Information Center." International Window Film Association (IWFA) website. Accessed March 2013 from the World Wide Web: <http://www.iwfa.com>.
- 18 "Fortified for Existing Homes Program." Insurance Institute for Business & Home Safety website. Accessed March 2013 from the World Wide Web http://ofb.ibhs.org/fortified?type=fortified_existing_homes.
- 19 "Guidelines for Handling Water Damaged Electrical Equipment." National Electrical Manufacturers Association (NEMA) website. Copyright 2010. Accessed May 2010 from the World Wide Web: http://www2.dnr.cornell.edu/ext/EDEN/guidelines_handling_water_damaged_elect equip.pdf.
- 20 "Gable End Retro-fit Video." Institute for Business and Home Safety (IBHS) website. Accessed May 2010 from the World Wide Web: <http://www.disastersafety.org>.
- 21 "Building Performance: Hurricane Iniki in Hawaii—Observations, Recommendations, and Technical Guidance." FEMA in cooperation with the State of Hawai'i Civil Defense and Kaua'i County. 1993.
- 22 "Protecting Your Property from Flooding." FEMA website. June 4, 2009. Accessed April 2010 from the World Wide Web: <http://www.fema.gov/plan/prevent/howto/index.shtm#4>.
- 23 "Residential- Reducing Wildfire Risk." Insurance Institute for Business & Home Safety (IBHS). 2012. Accessed April 2013 from the World Wide Web: http://www.disastersafety.org/wp-content/uploads/Wildfire-Residential_IBHS.pdf.
- 24 "Publication on the Combustibility of Landscape Mulches." Center for Fire Research and Outreach. 2011. Accessed April 2013 from the World Wide Web: <http://firecenter.berkeley.edu/node/65>.
- 25 "Fire Ratings for Construction Materials." eXtention. 2013. Accessed April 2013 from the World Wide Web: <http://www.extension.org/pages/31039/fire-ratings-for-construction-materials>.
- 26 "Fire Ratings for Roofing Material." eXtention. 2013. Accessed April 2013 from the World Wide Web: <http://www.extension.org/pages/23741/fire-ratings-for-roofing-material>.

- 27 “Protecting Decks, Patios, and Porches.” Insurance Institute for Business & Home Safety (IBHS). 2012. April 2013 from the World Wide Web: http://www.disastersafety.org/wildfire/decks_patios_porches/.
- 28 “Builders Wildfire Mitigation Guide.” Center for Fire Research and Outreach. 2011. Accessed from the World Wide Web: <http://firecenter.berkeley.edu/bwmg/decks-1.html>.
- 29 “Electrical Safety Precautions During Disasters.” Electrical Safety Foundation International website. Copyright 2010. Accessed May 2010 from the World Wide Web: http://www.pueblo.gsa.gov/cic_text/housing/safety/precautions.htm.
- 30 “Guidelines for Handling Water Damaged Electrical Equipment.” National Electrical Manufacturers Association (NEMA) website. Copyright 2010. Accessed May 2010 from the World Wide Web: http://www2.dnr.cornell.edu/ext/EDEN/guidelines_handling_water_damaged_elect equip.pdf.
- 31 “Make Mitigation Happen.” Florida Division of Emergency Management. 2013. Accessed from the World Wide Web: <http://www.floridadisaster.org/Mitigation/RCMP/documents/Wind%20mitigation%20booklet.pdf>.
- 32 “Keeping a Household Inventory an Protecting Valuable Records.” Michael Olexa and Travis Walker. 2012. UF IFAS Extension. University of Florida. Publication DH138.
- 33 “Six Steps in Making an Insurance Claim.” Michael Olexa and Travis Walker. 2012. UF IFAS Extension. University of Florida. Publication DH199.
- 34 “The Effects of Climate Change on Florida’s Ocean & Coastal Resources.” (A special report to the Florida Energy and Climate Comission and the People of Florida). Florida Oceans and Coastal Council. 2009.
- 35 “6.5 Global Climate Projections in Chapter 10 in Climate Change 2007: Working Group I: The Physical Science Basis.” Intergovernmental Panel on Climate Change (IPCC). 2007. Accessed March 2013 on the World Wide Web: ipcc.ch/publications_and_data/publications_and_data.shtml.
- 36 Ibid.
- 37 “Integrated Water Quality Assessment for Florida. Tallahassee, FL .” Florida Department of Environmental Protection (FDEP), Division of Environmental Assessment and Restoration- Bureau of Watershed Management. 2008.
- 38 “Climate of Florida.” Winsberg, M. Florida Climate Center. Accessed March 2013 from the World Wide Web <http://climatecenter.fsu.edu/images/fcc/climateofflorida.pdf>.
- 39 “Regional Climate Impacts: Southeast: Global Climate Change Impacts in the United States.” U.S. Global Change Research Program. 2009. Accessed March 2013 on the World Wide Web: <http://www.globalchange.gov/images/cir/pdf/southeast.pdf>.

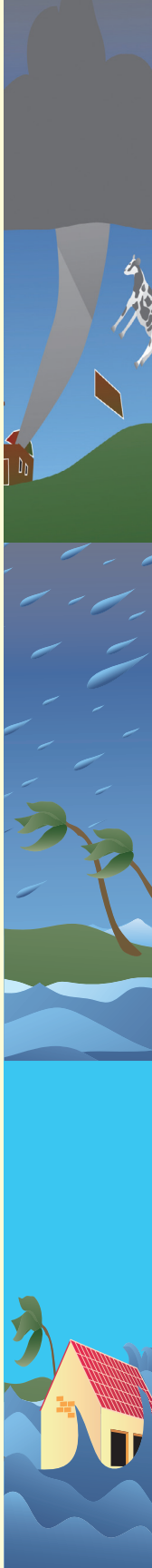

- 
- 40 “NCDC Announces Warmest Year on Record for Contiguous United States.” National Oceanic and Atmospheric Administration (NOAA) National Climate Data Center (NCDC). 2013. Accessed April 2013 from the World Wide Web: <http://www.ncdc.noaa.gov/news/ncdc-announces-warmest-year-record-contiguous-us>.
- 41 “A Region Responds to a Changing Climate Regional Climate Action Plan.” Southeast Florida Regional Climate Change Compact Counties. 2012.
- 42 “Climate Scenarios: A Florida-Centric View, Florida Climate Change Task Force.” Misra, V., E. Carlson, R. K. Craig, D. Enfield, B. Kirtman, W. Landing, S.-K. Lee, D. Letson, F. Marks, J. Obeysekera, M. Powell, S.-I. Shin. 2011. Accessed March 2013 from the World Wide Web: <http://floridaclimate.org/whitepapers/>.
- 43 “Mid-Century Expectations for Tropical Cyclone Activity and Florida Rainfall. In Climate Scenarios: A Florida-Centric View- A White Paper on Climate Scenarios for Florida.” Enfield, D., S.-K. Lee, F. Marks, and M. Powell. 2011.
- 44 Id. citation 42.
- 45 Id. citation 43.
- 46 Id. citation 39.
- 47 “Economic Impacts of Climate Change on Florida: Estimates from Two Studies.” Borisova, T., N. Breuer, and R. Carriker, 2011. Publication FE787.
- 48 “Sea Level Changes in the. Southeastern United States. Past, Present, and Future.” Mitchum, G. 2011.
- 49 Id. citation 39.
- 50 “Climate Change: What you can do?” United States Environmental Protection Agency. 2013. Accessed from the World Wide Web: <http://www.epa.gov/climatechange/wycd/>.
- 51 Ibid.
- 52 “Coastal No Adverse Impact Handbook.” NOAA & ASFPM. 2007. Accessed April 2013 from the World Wide Web: http://www.floods.org/NoAdverseImpact/CNAI_Handbook/CNAI_Handbook.pdf.
- 53 “Dune Vegetation.” McGraw-Hill Access Science. 2013. Accessed March 2013 from the World Wide Web: <http://www.accessscience.com/overflow.aspx?SearchInputText=Plant+ecology&ContentTypeSelect=10&term=Plant+ecology&rootID=593000>.
- 54 “Recommended Florida Native Beach and Dune Plants for Beachfront Properties and Dune Restoration.” Florida Department of Environmental Protection (FDEP). 2009. Accessed April 2013 from the World Wide Web: <http://www.dep.state.fl.us/beaches/publications/pdf/RecBch&DunePlants.pdf>
- 55 “Native Plants for Coastal Dune Restoration: What, When, and How for Florida.” Williams, M.J. 2007. Accessed April 2013 from the World Wide Web: <http://www.plant-materials.nrcs.usda.gov/pubs/flpmspu7474.pdf>

56 "Beach and Dune Walkover Guidelines." Florida Department of Environmental Protection (FDEP). 2006. Accessed April 2013 from the World Wide Web: <http://www.dep.state.fl.us/beaches/publications/pdf/wlkovrgl06.pdf>

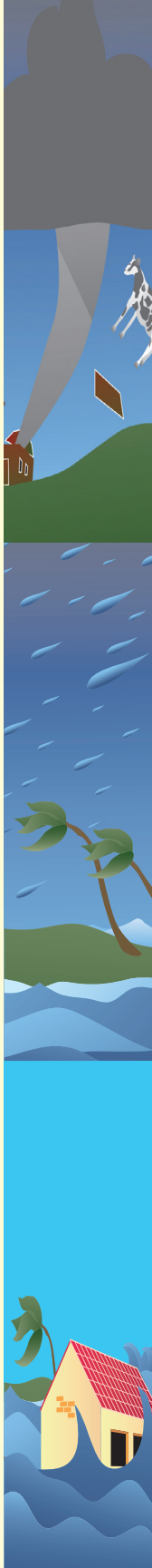

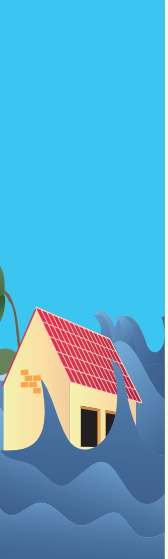
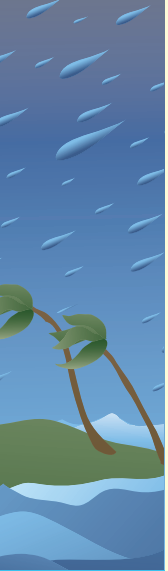

Acronyms & Abbreviations

ASTM – American Society for Testing and Materials

USACE – United States Army Corps of Engineers

BFE – base flood elevation

CCCL – Coastal Construction Control Line

CFL – Compact fluorescent light bulb

CO – Carbon Monoxide

Citizens – Citizens Property Insurance Corporation

DBPR – Florida Department of Business and Professional Regulation

DMA2K – Disaster Mitigation Act of 2000

DOI – United States Department of Interior

EAS – Emergency Alert System

EF – Enhanced Fujita

EPA – Environmental Protection Agency

F – Fujita (Scale to estimate tornado speeds based on damage left behind)

FDEM – Florida Division of Emergency Management

FDEP – Florida Department of Environmental Protection

FEMA – Federal Emergency Management Agency

FFS – Florida Forest Service

FIRM – Flood Insurance Rate Map

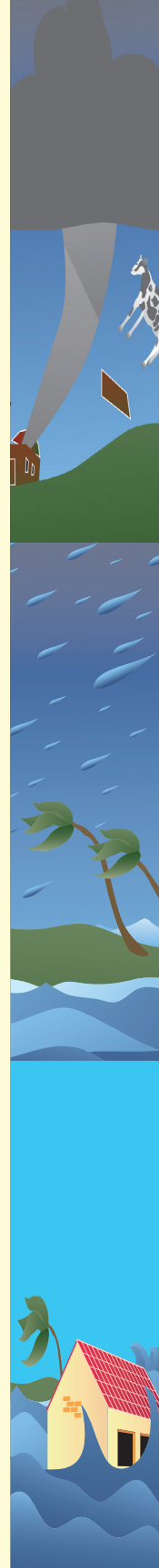



FWC - Florida Fish and Wildlife Conservation Commission

Florida A&M - Florida Agricultural and Mechanical University

GFCI - Ground fault circuit interrupter

HMA - Hazard Mitigation Assistance

IBHS - Institute for Business & Home Safety

IWFA - International Window Film Association

LED - Light-emitting diode

NEMA - National Electrical Manufacturers Association

NEPP - Neighborhood Emergency Preparedness Program

NEWIS - Extreme Weather Information Sheet

NFIP - National Flood Insurance Program

NOAA - National Oceanic and Atmospheric Administration

NWS - National Weather Service

RSG - Ready, Set, Go! Program

Stafford Act - Robert T Stafford Disaster Relief and Emergency Assistance Act

TAS - Testing Application Standard

USDA - United States Department of Agriculture

WUI - Wildland/Urban Interface

Useful Links & Resources

This Handbook: fl.stormsmart.org/handbook

Administration on Aging: www.aoa.gov

American Red Cross: www.redcross.org

First Aid Checklist: www.redcross.org/prepare/location/home-family/get-kit/anatomy

Pets and Disaster Safety Checklist: www.redcross.org/images/MEDIA_CustomProductCatalog/m3640126_PetSafety.pdf

Chapters:

Center Panhandle Chapter: www.redcrosspanamacity.org

Florida's West Coast Region-Southwest Florida Chapter: www.redcross.org/fl/sarasota

Mid-Florida Chapter: www.redcross.org/fl/orlando

North Central Florida Chapter: www.redcrossnfc.org/

Northeast Florida Chapter: www.redcross.org/fl/jacksonville

Northwest Florida Chapter: www.redcross.org/fl/pensacola

Palm Beaches/ Treasure Coast Chapter: www.redcross.org/fl/palm-beach

South Florida Chapter: www.redcross.org/fl/miami

Centers for Disease Control and Prevention:

Learn How to Shelter in Place: www.bt.cdc.gov/preparedness/shelter

Tips for Preventing Heat-Related Illness: www.bt.cdc.gov/disasters/extremeheat/heattips.asp

Seasonal Influenza (Flu): www.cdc.gov/flu

The "An Ounce of Prevention" Campaign: www.cdc.gov/ounceofprevention

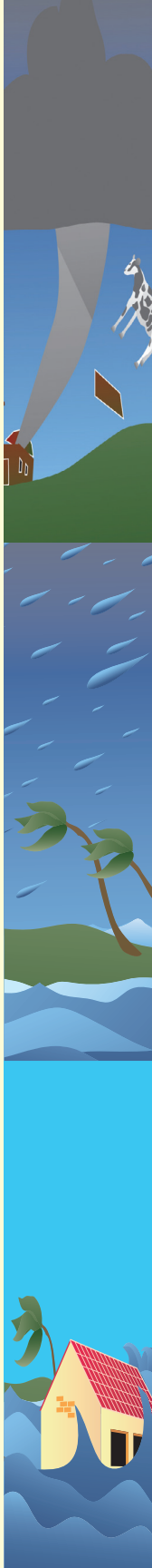



Children's Medical Services: www.cms-kids.com/

Citizens Property Insurance Corporation: www.citizensfla.com

Family Doctor www.familydoctor.org/otc.xml

Federal Emergency Management Agency: www.FEMA.gov

Library for document search: www.fema.gov/library/index.jsp

Pet Preparedness: www.ready.gov/caring-animals

Protecting Your Property from Flooding: www.fema.gov/protect-your-property-or-business-disaster#4

Ready site: www.ready.gov/build-a-kit

Rebuild Smarter and Stronger: www.fema.gov/safer-stronger-protected-homes-communities

Residential Coastal Construction: www.fema.gov/residential-coastal-construction

Shelter Information: www.ready.gov/shelter

Florida Division of Emergency Management: www.floridadisaster.org

Hurricane Retrofit Guide: www.floridadisaster.org/hrg/index.asp

Evacuation Routes: www.floridadisaster.org/PublicMapping/index.htm

List of Shelters: www.floridadisaster.org/shelters

Disabilities and Special Needs: www.floridadisaster.org/disability

Hazard Mitigation Grant Program: www.floridadisaster.org/Mitigation/Hazard/index.htm

Mitigation: www.floridadisaster.org/mitigation

Shutter Selection Matrix: www.floridadisaster.org/hrg/downloads/HRG_Shutter_Matrix.pdf

Protecting your Home from Wind Damage: www.floridadisaster.org/EMTOOLS/Severe/documents/agstwnd-fema.pdf

Tornado Worksheet: www.floridadisaster.org/mitigation/Hazard/Documents/Tornado_Worksheet.pdf

Florida's Aging and Disability Resource Centers: www.agingresourcecentersofflorida.org/

Florida Bar: www.floridabar.org

Florida Department of Business & Professional Regulation: www.myfloridalicense.com/dbpr

Florida Department of Environmental Protection: www.floridadep.org

Beaches and Coastal Systems: www.floridadep.org/beaches

Florida Department of Health

County Health Departments: www.doh.state.fl.us/chdsitelist.htm

Flu and Immunization Clinic Finder: www.pandemicflu.gov

Home Care Series Satellite Broadcast: www.med.fsu.edu/index.cfm?page=healthAffairs.homecareseries

Home Care Series Training Manual: www.doh.state.fl.us/demo/BPR/NEPP/hcs_manual.html

Neighborhood Emergency Preparedness: www.doh.state.fl.us/demo/BPR/NEPP/nepp.html

Florida Humane Society: www.floridahumanesociety.org/

Food and Drug Administration: www.fda.gov

Food and Drug Administration resources for medicine safety: www.fda.gov/Drugs/ResourcesForYou/Consumers/BuyingUsingMedicineSafely/UnderstandingOver-the-CounterMedicines/ucm093514.htm

Institute for Business & Home Safety: www.ibhs.org –or– www.disastersafety.org

International Hurricane Protection Association: www.inthpa.com

International Window Film Association: www.iwfa.com

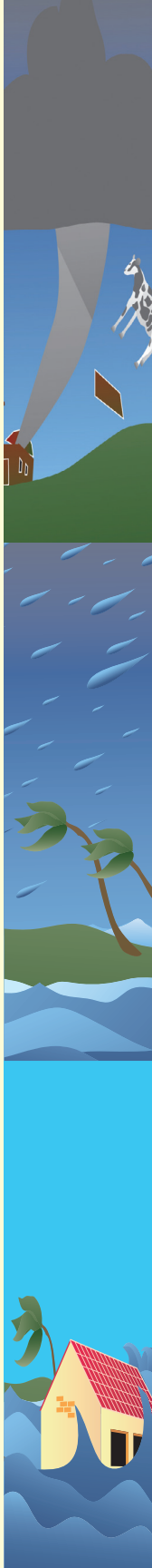



National Child Traumatic Stress Network: www.nctnet.org/nccts/nav.dp?pid=ctr_aud_prnt_chlg

National Electrical Manufacturers Association: www.nema.org

National Flood Insurance Program: www.floodsmart.gov

National Oceanic and Atmospheric Administration: www.noaa.gov

National Weather Radio Stations: www.nws.noaa.gov/nwr/stations.php?State=FL

University of Florida IFAS - Disaster Planning Tips for Senior adults: www.edis.ifas.ufl.edu/fy620



An Equal Opportunity Institution. Extension Service, University of Florida, Institute of Food and Agricultural Sciences, Nick T. Place, Dean. Information on copies for purchase is available from IFAS Extension Bookstore, University of Florida, P.O. Box 110011, Gainesville, FL 32611-0011 (visit our website at: ifasbooks.ufl.edu). Information about alternate formats is available from IFAS Communications, University of Florida, P.O. Box 110810, Gainesville, FL 32611-0810. Published May 2013.

ISBN 978-0-9850952-2-2

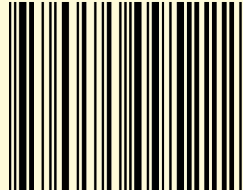

9 780985 095222

